

MINI KITCHEN

MINI & COMPACT



www.stengel-steelconcept.com

STENDEL METAL KITCHENS - STEEL IN A BEAUTIFUL AND FUNCTIONAL DESIGN



Rev 04.24

stengel
KITCHENS

You can download our mini kitchen catalogue, general information on our products, data sheets and operating instructions for our electrical appliances here:

www.stengel-steelconcept.com



Picture: MPMOS120 with wall cupboards in colour sand

stengel
KITCHENS

CONTENTS

GENERAL INFORMATION 04

| | |
|--|----|
| Stengel mini kitchen features & benefits | 04 |
| Stengel mini kitchen comparison | 06 |

MINI KITCHEN PREMIUMLINE MP 08

| | |
|-----------------|----|
| 100/110 cm wide | 16 |
| 120 cm wide | 18 |
| 150 cm wide | 20 |
| 160 cm wide | 24 |
| 170 cm wide | 26 |
| 180 cm wide | 28 |

MINI KITCHEN KITCHENLINE MK 30

| | |
|-------------|----|
| 90 cm wide | 36 |
| 100 cm wide | 36 |
| 120 cm wide | 38 |
| 150 cm wide | 40 |

MINI KITCHEN EASYLINE ME 42

| | |
|-------------|----|
| 100 cm wide | 44 |
| 120 cm wide | 45 |

SET STUDIOLINE SL 46

| | |
|--|----|
| Studioline SLD - H2060 | 50 |
| Studioline SLD - H2220 | 50 |
| Studioline SLDH - H2220 with extractor | 52 |

CUPBOARD KITCHEN SKM 54

| | |
|-----------------|----|
| basic model | 56 |
| accessories | 58 |
| larder cupboard | 59 |

WALL CUPBOARDS/ LARDER CUPBOARDS 60

| | |
|--|----|
| wall cupboards HS-H560 | 62 |
| wall cupboards HS-H720 | 64 |
| wall cupboards with appliances HSMW/HSDH | 66 |
| larder cupboard HO 60 | 70 |
| larder cupboard with oven HOB 60 | 70 |

ACCESSORIES / ELECTRICAL APPLIANCES 72

| | |
|----------------------------|----|
| wall rack | 72 |
| infill pannels | 74 |
| splash backs / side cheeks | 75 |
| accessories / taps | 76 |
| electrical appliances | 78 |

INFORMATIONS 82

| | |
|--------------------------------------|----|
| projects | 82 |
| Stengel Steel Concept & Stengel GmbH | 86 |
| delivery / packaging / partner | 88 |
| connection scheme | 90 |

you will find our general terms and conditions
on www.stengel-steelconcept.com

STENGEL MINI KITCHEN

FEATURES & BENEFITS

We believe that a kitchen has to be able to do everything - regardless of size. If you have only little space at home, in your office or studio or place of work we have the mini kitchen that suits your needs. Our **mini kitchens** will fulfill your requirements and wishes perfectly. Almost all models are delivered assembled and ready to plug in and cook.

Mini kitchen made from metal and its benefits:

We only use steel and stainless steel from European trade.

Powder coating

In a **Stengel kitchen**, powder-coated parts are constructed with our own state-of-the-art powder coating system. The coating makes the surfaces much more durable than ordinary liquid paint.

Stainless steel

We use stainless and acid-resistant stainless steel 1.4301 (X5CrNi18-10), which is approved for temperatures up to 600° Celsius, in our worktops, fronts and other parts.

Rust resistant

The stainless steel and powder-coated metal used in our products is resistant to water vapour, damp and other climatic influences - leaving no breeding ground for rust.

Easy to clean

Stengel mini kitchens are really easy to clean thanks to their smooth, non-porous surfaces.

Environmentally friendly

100% recyclable steel and no toxic substances mean we are making a vital contribution to both your health and the sustainable use of environmental resources. Eco-certification according to DIN EN 14001 is guaranteed.

Fire resistant

Steel kitchens never go up in flames, steel cannot self-ignite and does not provide any fuel for a fire.

Odourless

Powder-coated metal is odourless - even after thousands of hours of cooking, **Stengel kitchens** still smell fresh once cleaned, as the material does not absorb any foreign odours.

Advantages of metal kitchens from Stengel compared to wooden kitchens:

- ◆ high durability
- ◆ no material deterioration compared to wood
- ◆ low installation costs
- ◆ simple installation
- ◆ timeless style
- ◆ no problems with damages caused by water
- ◆ space saving
- ◆ easy to maintain surfaces
- ◆ hygienic and anti-bacteria
- ◆ Non-flammable / complies with fire safety regulations



Picture: MPM120A with wall cupboard and larder cupboard in colour white

COMPARISON OF KITCHEN MODELS

Our mini and compact kitchens have a wide range of applications. The kitchen that would be installed in a portacabin, for example, would be different to one installed in a holiday apartment. That's why we offer three different model series with different price points, features and designs.

MINI KITCHEN ME EASYLINE:

Features:

- ◆ Metal cupboard unit in powder coated finish, filled double-walled fronts
- ◆ Fridge 48 cm wide with 2* - freezer
- ◆ Available in widths 100 and 120 cm
- ◆ Deep drawn standard pantry tops with ventilation holes on top, integrated bowl, drainer and hobs - front mounted controls
- ◆ Hob: electric hotplates or without hotplates
- ◆ Metal cupboard unit without handles with push to open door
- ◆ Shelves as accessories
- ◆ Standard colour white
- ◆ There is a slight colour difference between fridge front and base structure



MINI KITCHEN MK KITCHENLINE:

Additional special features to ME Easyline:

- ◆ Fridge 50cm wide with 4* - freezer
- ◆ Available in widths of 90 - 150 cm
- ◆ Electric hotplates, ceramic hob or without hob
- ◆ Metal handles in kitchen colour
- ◆ Available with microwave and oven (*1)
- ◆ Five additional colours (*2) bordeaux, green apple, sand, mocha and black
- ◆ For white version: There is a slight colour difference between fridge front and base structure



MINI KITCHEN MP PREMIUMLINE:

Additional special features to MK Kitchenline:

- ◆ Metal covered fridge door
- ◆ Available in widths of 100 - 180 cm
- ◆ Pantry top made of brushed stainless steel with ventilation holes in front, built-in bowl with drainer, tap hole, filter basket and siphon
- ◆ Ceramic hob, induction hob or without hob
- ◆ Modern bar handle in stainless steel
- ◆ Drawers (*1) with softclose
- ◆ Also with microwave with cooking function 20l and 30l, dishwasher and oven (*1)
- ◆ Three additional colours – slate grey, teal and stainless steel



(*1) depending on the model (*2) for colored kitchens with metal covered fridge door

MP PREMIUMLINE MINI KITCHEN

**FLEXIBLE AND FUNCTIONAL -
THE PERFECT KITCHEN FOR EVERYONES NEEDS**

If style and functionality are of special value to you then the **Stengel Premiumline** range of kitchens is the perfect choice.

Our **mini kitchen** is made of powder coated sheet metal and supplied with double-walled doors which are filled with insulation to give strength and a solid feel. Classic design handles and high quality metal pull-out rails complete a perfect picture.

Classical or modern a style to meet everyones taste.

The **Premiumline** models become a fully-equipped kitchen with the option to choose from microwave, microwave oven with cooking function, dishwasher or oven. Available in the widths 100, 110, 120, 150, 160, 170 and 180 cm.

Please refer to the following pages for details of all the models.





Picture: MPMOS180 A with wallcupboards in colour bordeaux

MP PREMIUMLINE IN COLOUR

A CHEERFUL PLAY OF COLORS

Make your space look more vibrant and inviting by choosing a mini kitchen in a colour that matches your personality and interior style.

With the cheerful color selection of our **Stengel kitchens**, you can express your personal style and taste.

Create your unique and individual space with a Stengel kitchen in sand, green, mocha, red, black or teal....



SLATE GREY



MOCHA METALLIC



STAINLESS STEEL



Picture: MPGS160 with wall cupboards in colour slate grey



TEAL



BLACK MATT



GREEN APPLE



WHITE



BORDEAUX



SAND MATT

MODELS

MINI KITCHEN MP PREMIUMLINE



MP 100
see page 17



MPGS 110
see page 17



MPGS 120
see page 19



MP 100 S
see page 17



MP 120
see page 19



MPMOS 120
see page 19



MPM 100
see page 17



MP 120 A
see page 19



MP 150
see page 20



MP 110 S
see page 17



MPM 120 A
see page 19



MPM 150
see page 21

MP PREMIUMLINE



MPMOS 150
see page 21



MPB 150
see page 21



MPGS 160
see page 25



MPS4 150
see page 21



MP 160
see page 24



MPGSM 160
see page 25



MPGS 150
see page 21



MPM 160
see page 24



MPGMS3 160
see page 25



MPGSM 150
see page 21



MPMOS 160
see page 25



MPGG 160
see page 25

MODELS

MINI KITCHEN MP PREMIUMLINE



MPB 160
see page 25



MPGSMOS 170
see page 27



MPB 170
see page 27



MP 170
see page 26



MPGS 170
see page 27



MP 180 A
see page 28



MPM 170
see page 26



MPGSM 170
see page 27



MPM 180 A
see page 28



MPMOS 170
see page 27



MPGG 170
see page 27



MPMOS 180 A
see page 29



MPGSMOS 180
see page 29



MPB 180 A
see page 29



MPGS 180 A
see page 29





MPGSM 180 A
see page 29



MPGG 180 A
see page 29

MP
PREMIUMLINE

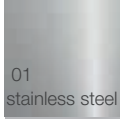
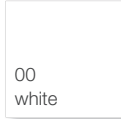
Colour Range Premiumline

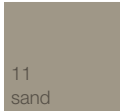
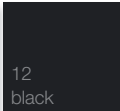
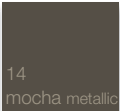
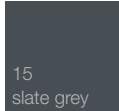
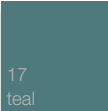
| | | | | |
|---|---|---|---|---|
| stainless steel | | gloss powder coating | | |
|  |  |  |  | |
| 01 stainless steel | 00 white | 03 bordeaux | 13 green apple | |
| matt powder coating | | structure powder coating | | |
|  |  |  |  |  |
| 11 sand | 12 black | 14 mocha metallic | 15 slate grey | 17 teal |



picture: MPM 100 S - with hob

MINI KITCHEN PREMIUMLINE 100-110CM MP 100 - 110

- ◆ Fridge 4*-freezer (standard) or without fridge(*)
- ◆ Premium pantry top brushed and ground, built-in bowl Line 60, drain set and siphon, tap hole, with ceramic hob, induction hob or without hob
- ◆ Metal cupboard unit in white powder coated finish, cupboards have no back panels, drawers with softclose
- ◆ Filled double-walled fronts, powder-coated, bar handle in stainless steel
- ◆ Fridge with metal covered fridge door
- ◆ Working height 89 cm
- ◆ Inclusive all listed electrical appliances
- ◆ Available in eight different colours
- ◆ Delivered assembled and ready to plug in

Top version



ceramic or induction hob



without hob

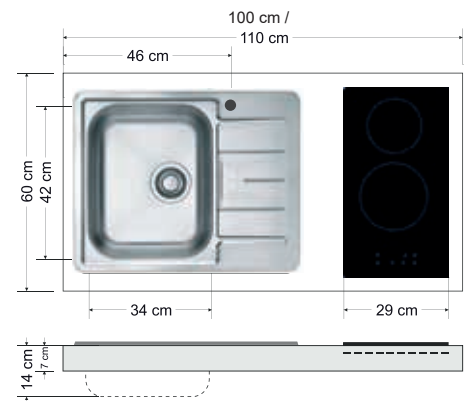

Colour Range Premiumline

stainless steel



gloss powder coating

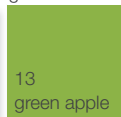

matt powder coating

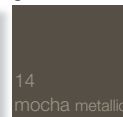
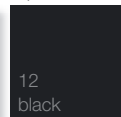

structure powder coating

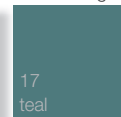
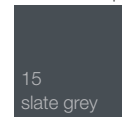

| article no. | colour | hob | bowlside |
|-------------------|--------|-----------|------------|
| 10100 000631 - XX | | ceramic | bowl right |
| 10100 000641 - XX | | ceramic | bowl left |
| 10100 000651 - XX | | without | bowl right |
| 10100 000661 - XX | | without | bowl left |
| 10100 000671 - XX | | induction | bowl right |
| 10100 000681 - XX | | induction | bowl left |

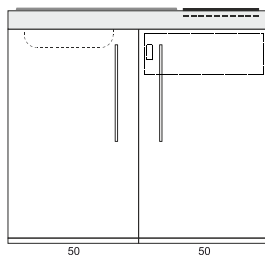

MP 100

fridge

dimensions: 100 x 60 x 89 cm (WxDxH)

| article no. | colour | hob | bowlside |
|-------------------|--------|-----------|------------|
| 10100 100631 - XX | | ceramic | bowl right |
| 10100 100641 - XX | | ceramic | bowl left |
| 10100 100651 - XX | | without | bowl right |
| 10100 100661 - XX | | without | bowl left |
| 10100 100671 - XX | | induction | bowl right |
| 10100 100681 - XX | | induction | bowl left |

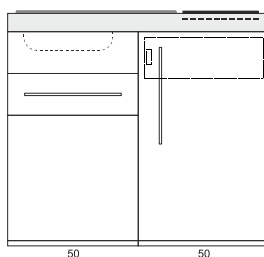

MP 100 S

fridge

one drawer

under-sink cupboard with door and touch closure

dimensions: 100 x 60 x 89 cm (WxDxH)

| article no. | colour | hob | bowlside |
|-------------------|--------|-----------|------------|
| 10100 010631 - XX | | ceramic | bowl right |
| 10100 010641 - XX | | ceramic | bowl left |
| 10100 010651 - XX | | without | bowl right |
| 10100 010661 - XX | | without | bowl left |
| 10100 010671 - XX | | induction | bowl right |
| 10100 010681 - XX | | induction | bowl left |

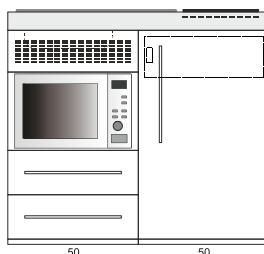

MPM 100

20l microwave

fridge

two drawers

dimensions: 100 x 60 x 89 cm (WxDxH)

| article no. | colour | hob | bowlside |
|-------------------|--------|-----------|------------|
| 10110 102631 - XX | | ceramic | bowl right |
| 10110 102641 - XX | | ceramic | bowl left |
| 10110 102651 - XX | | without | bowl right |
| 10110 102661 - XX | | without | bowl left |
| 10110 102671 - XX | | induction | bowl right |
| 10110 102681 - XX | | induction | bowl left |

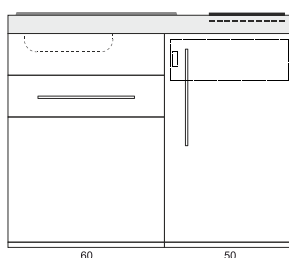

MP 110 S

fridge

one drawer

under-sink cupboard with door and touch closure

dimensions: 110 x 60 x 89 cm (WxDxH)

| article no. | colour | hob | bowlside |
|-------------------|--------|-----------|------------|
| 10110 680631 - XX | | ceramic | bowl right |
| 10110 680641 - XX | | ceramic | bowl left |
| 10110 680651 - XX | | without | bowl right |
| 10110 680661 - XX | | without | bowl left |
| 10110 680671 - XX | | induction | bowl right |
| 10110 680681 - XX | | induction | bowl left |

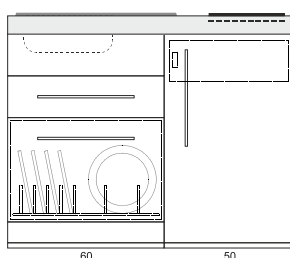

MPGS 110

dishwasher

fridge

one drawer

dimensions: 110 x 60 x 89 cm (WxDxH)



picture: MPM 120 A - with hob

MINI KITCHEN PREMIUMLINE 120CM MP 120

- ◆ Fridge 4*-freezer (standard) or without fridge(*)
- ◆ Premium pantry top brushed and ground, built-in bowl Line 60, drain set and siphon, tap hole, with ceramic hob, induction hob or without hob
- ◆ Metal cupboard unit in white powder coated finish, cupboards have no back panels, drawers with softclose
- ◆ Filled double-walled fronts, powder-coated, bar handle in stainless steel
- ◆ Fridge with metal covered fridge door
- ◆ Working height 89 cm
- ◆ Inclusive all listed electrical appliances
- ◆ Available in eight different colours
- ◆ Delivered assembled and ready to plug in

Top version



ceramic or induction hob



without hob

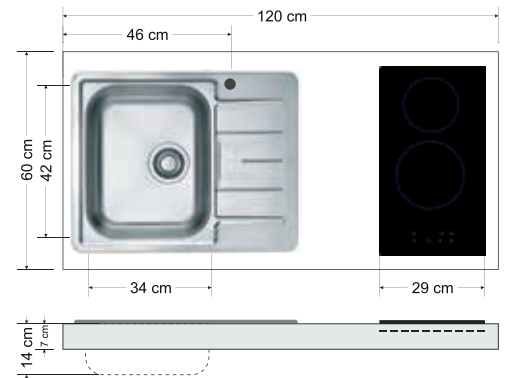

Colour Range Premiumline

stainless steel

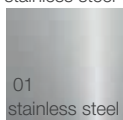

01
stainless steel

gloss powder coating



00
white



03
bordeaux

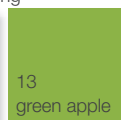

13
green apple

matt powder coating



11
sand

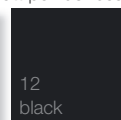

12
black

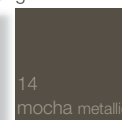

14
mocha metallic

structure powder coating

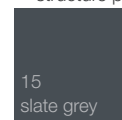

15
slate grey

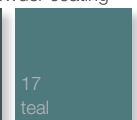

17
teal

| article no. | colour | hob | bowlside |
|-------------------|--------|-----------|------------|
| 10120 001631 - XX | | ceramic | bowl right |
| 10120 001641 - XX | | ceramic | bowl left |
| 10120 001651 - XX | | without | bowl right |
| 10120 001661 - XX | | without | bowl left |
| 10120 001671 - XX | | induction | bowl right |
| 10120 001681 - XX | | induction | bowl left |



MP 120

fridge
2-door cupboard 50/20cm

dimensions: 120 x 60 x 89 cm (WxDxH)

| article no. | colour | hob | bowlside |
|-------------------|--------|-----------|------------|
| 10120 102631 - XX | | ceramic | bowl right |
| 10120 102641 - XX | | ceramic | bowl left |
| 10120 102651 - XX | | without | bowl right |
| 10120 102661 - XX | | without | bowl left |
| 10120 102671 - XX | | induction | bowl right |
| 10120 102681 - XX | | induction | bowl left |

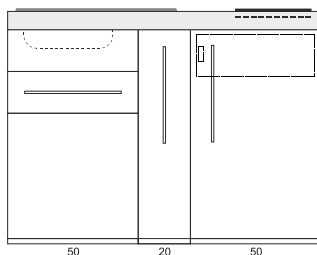

MP 120 A

fridge
pull out unit 20 cm with two trays
under-sink cupboard with door and touch closure
one drawer

dimensions: 120 x 60 x 89 cm (WxDxH)

| article no. | colour | hob | bowlside |
|--------------------|--------|-----------|------------|
| 10120 012631 - XX | | ceramic | bowl right |
| 10120 012641 - XX | | ceramic | bowl left |
| 10120 012651 - XX | | without | bowl right |
| 110120 012661 - XX | | without | bowl left |
| 10120 012671 - XX | | induction | bowl right |
| 10120 012681 - XX | | induction | bowl left |

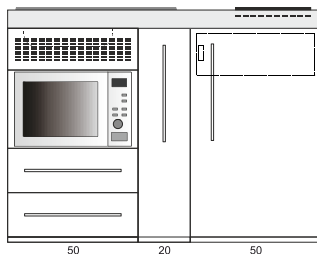

MPM 120 A

20l microwave
fridge
pull out unit 20 cm with two trays
two drawers

dimensions: 120 x 60 x 89 cm (WxDxH)

| article no. | colour | hob | bowlside |
|-------------------|--------|-----------|------------|
| 10120 390631 - XX | | ceramic | bowl right |
| 10120 390641 - XX | | ceramic | bowl left |
| 10120 390651 - XX | | without | bowl right |
| 10120 390661 - XX | | without | bowl left |
| 10120 390671 - XX | | induction | bowl right |
| 10120 390681 - XX | | induction | bowl left |

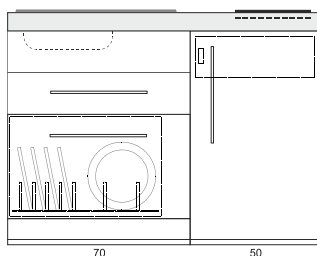

MPGS 120

dishwasher
fridge
one drawer

dimensions: 120 x 60 x 89 cm (WxDxH)

| article no. | colour | hob | bowlside |
|-------------------|--------|-----------|------------|
| 10120 800631 - XX | | ceramic | bowl right |
| 10120 800641 - XX | | ceramic | bowl left |
| 10120 800651 - XX | | without | bowl right |
| 10120 800661 - XX | | without | bowl left |
| 10120 800671 - XX | | induction | bowl right |
| 10120 800681 - XX | | induction | bowl left |

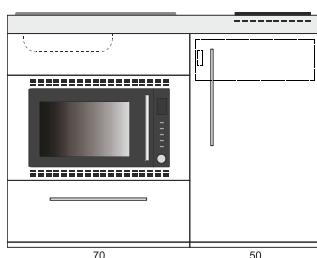

MPMOS 120

30l microwave /oven combination
fridge
one drawer

dimensions: 120 x 60 x 89 cm (WxDxH)



picture: MPMOS 150 - with hob

MINI KITCHEN PREMIUMLINE 150CM MP 150

- ◆ Fridge 4*-freezer (standard) or without fridge(*)
- ◆ Premium pantry top brushed and ground, built-in bowl Line 60, drain set and siphon, tap hole, with ceramic hob, induction hob or without hob
- ◆ Metal cupboard unit in white powder coated finish, cupboards have no back panels, drawers with softclose
- ◆ Filled double-walled fronts, powder-coated, bar handle in stainless steel
- ◆ Fridge with metal covered fridge door
- ◆ Working height 89 cm
- ◆ Inclusive all listed electrical appliances
- ◆ Available in eight different colours
- ◆ Delivered assembled and ready to plug in

Top version



ceramic or induction hob



without hob

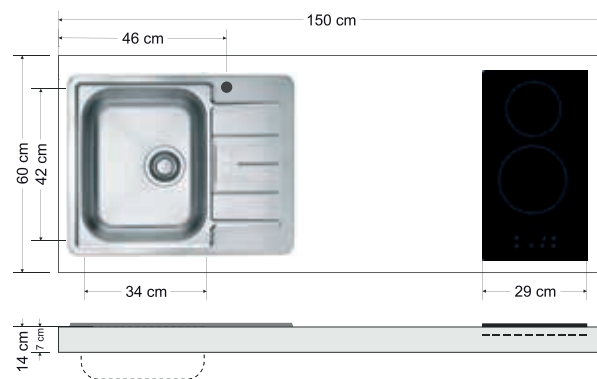

Colour Range Premiumline

stainless steel

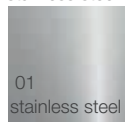

gloss powder coating

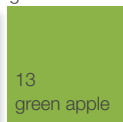
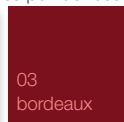

mat powder coating

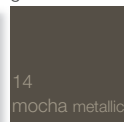
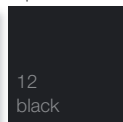

structure powder coating

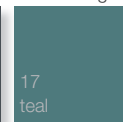
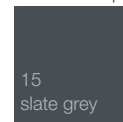

| article no. | colour | hob | bowlside |
|-------------------|--------|-----------|------------|
| 10150 100631 - XX | | ceramic | bowl right |
| 10150 100641 - XX | | ceramic | bowl left |
| 10150 100651 - XX | | without | bowl right |
| 10150 100661 - XX | | without | bowl left |
| 10150 100671 - XX | | induction | bowl right |
| 10150 100681 - XX | | induction | bowl left |

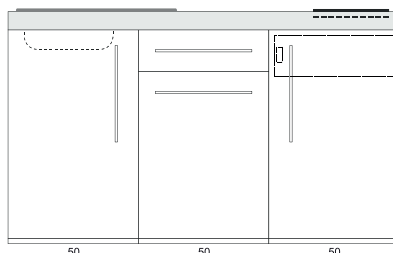

MP 150

fridge
one drawer

dimensions: 150 x 60 x 89 cm (WxDxH)

| article no. | colour | hob | bowlside |
|-------------------|-----------|-----------|------------|
| 10150 004631 - XX | ceramic | ceramic | bowl right |
| 10150 004641 - XX | ceramic | ceramic | bowl left |
| 10150 004651 - XX | without | without | bowl right |
| 10150 004661 - XX | without | without | bowl left |
| 10150 004671 - XX | induction | induction | bowl right |
| 10150 004681 - XX | induction | induction | bowl left |

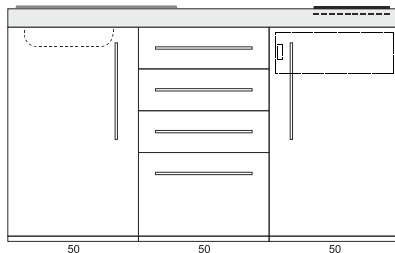

MPS4 150

fridge
four drawers

dimensions: 150 x 60 x 89 cm (WxDxH)

| article no. | colour | hob | bowlside |
|-------------------|-----------|-----------|------------|
| 10150 010631 - XX | ceramic | ceramic | bowl right |
| 10150 010641 - XX | ceramic | ceramic | bowl left |
| 10150 010651 - XX | without | without | bowl right |
| 10150 010661 - XX | without | without | bowl left |
| 10150 010671 - XX | induction | induction | bowl right |
| 10150 010681 - XX | induction | induction | bowl left |

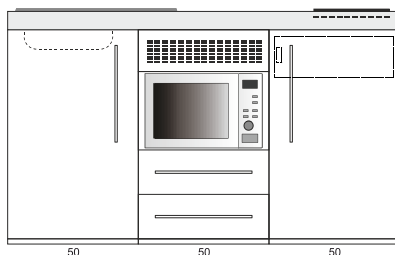

MPM 150

20l microwave
fridge
two drawers

dimensions: 150 x 60 x 89 cm (WxDxH)

| article no. | colour | hob | bowlside |
|-------------------|-----------|-----------|------------|
| 10150 809631 - XX | ceramic | ceramic | bowl right |
| 10150 809641 - XX | ceramic | ceramic | bowl left |
| 10150 809651 - XX | without | without | bowl right |
| 10150 809661 - XX | without | without | bowl left |
| 10150 809671 - XX | induction | induction | bowl right |
| 10150 809681 - XX | induction | induction | bowl left |

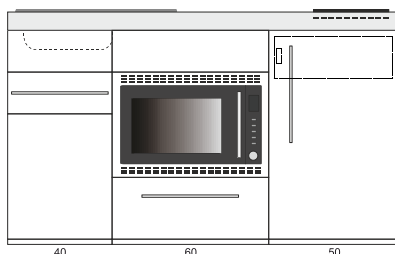

MPMOS 150

30l microwave /oven combination
fridge
under-sink cupboard with door and touch closure
two drawers

dimensions: 150 x 60 x 89 cm (WxDxH)

| article no. | colour | hob | bowlside |
|-------------------|-----------|-----------|------------|
| 10150 680631 - XX | ceramic | ceramic | bowl right |
| 10150 680641 - XX | ceramic | ceramic | bowl left |
| 10150 680651 - XX | without | without | bowl right |
| 10150 680661 - XX | without | without | bowl left |
| 10150 680671 - XX | induction | induction | bowl right |
| 10150 680681 - XX | induction | induction | bowl left |

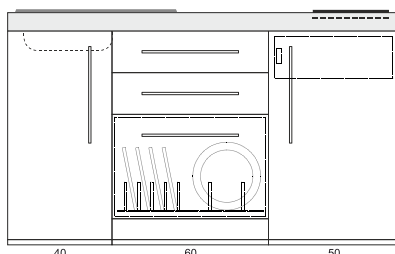

MPGS 150

dishwasher
fridge
two drawers

dimensions: 150 x 60 x 89 cm (WxDxH)

| article no. | colour | hob | bowlside |
|-------------------|-----------|-----------|------------|
| 10150 781631 - XX | ceramic | ceramic | bowl right |
| 10150 781641 - XX | ceramic | ceramic | bowl left |
| 10150 781651 - XX | without | without | bowl right |
| 10150 781661 - XX | without | without | bowl left |
| 10150 781671 - XX | induction | induction | bowl right |
| 10150 781681 - XX | induction | induction | bowl left |

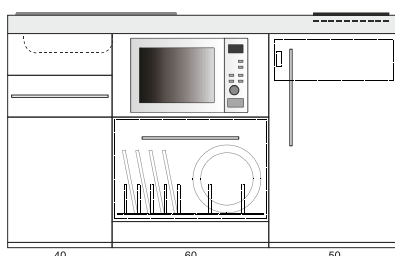

MPGSM 150

dishwasher
20l microwave
fridge
under-sink cupboard with door and touch closure
one drawer

dimensions: 150 x 60 x 89 cm (WxDxH)

| article no. | colour | hob | bowlside |
|-------------------|-----------|-----------|------------|
| 10150 106631 - XX | ceramic | ceramic | bowl right |
| 10150 106641 - XX | ceramic | ceramic | bowl left |
| 10150 106651 - XX | without | without | bowl right |
| 10150 106661 - XX | without | without | bowl left |
| 10150 106671 - XX | induction | induction | bowl right |
| 10150 106681 - XX | induction | induction | bowl left |

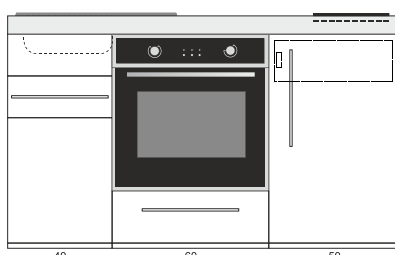

MPB 150

oven
fridge
under-sink cupboard with door and touch closure
two drawers

dimensions: 150 x 60 x 89 cm (WxDxH)



picture: MPGG160 with larder cupboard and wall cupboards in colour mocha metallic





picture: MPGSMS3 160 - with hob

MINI KITCHEN PREMIUMLINE 160CM MP 160

- ◆ Fridge 4*-freezer (standard) or without fridge(*)
- ◆ Premium pantry top brushed and ground, built-in bowl Line 60, drain set and siphon, tap hole, with ceramic hob, induction hob or without hob
- ◆ Metal cupboard unit in white powder coated finish, cupboards have no back panels, drawers with softclose
- ◆ Filled double-walled fronts, powder-coated, bar handle in stainless steel
- ◆ Fridge with metal covered fridge door
- ◆ Working height 89 cm
- ◆ Inclusive all listed electrical appliances
- ◆ Available in eight different colours
- ◆ Delivered assembled and ready to plug in

Colour Range Premiumline

stainless steel

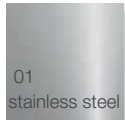

gloss powder coating

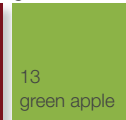
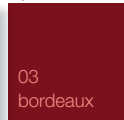
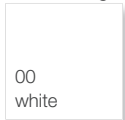

matt powder coating

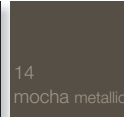
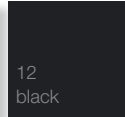

structure powder coating

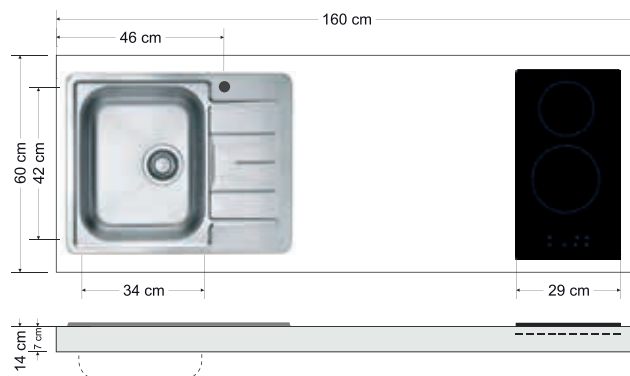
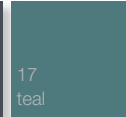
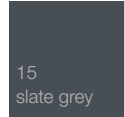

| article no. | colour | hob | bowlside |
|-------------------|--------|-----------|------------|
| 10160 080631 - XX | | ceramic | bowl right |
| 10160 080641 - XX | | ceramic | bowl left |
| 10160 080651 - XX | | without | bowl right |
| 10160 080661 - XX | | without | bowl left |
| 10160 080671 - XX | | induction | bowl right |
| 10160 080681 - XX | | induction | bowl left |

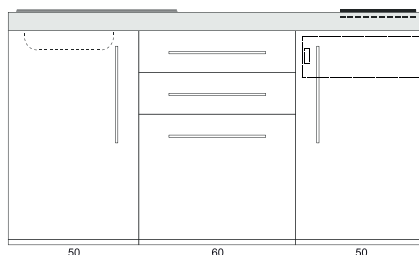

MP 160

fridge
two drawers

dimensions: 160 x 60 x 89 cm (WxDxH)

| article no. | colour | hob | bowlside |
|-------------------|--------|-----------|------------|
| 10160 030631 - XX | | ceramic | bowl right |
| 10160 030641 - XX | | ceramic | bowl left |
| 10160 030651 - XX | | without | bowl right |
| 10160 030661 - XX | | without | bowl left |
| 10160 030671 - XX | | induction | bowl right |
| 10160 030681 - XX | | induction | bowl left |

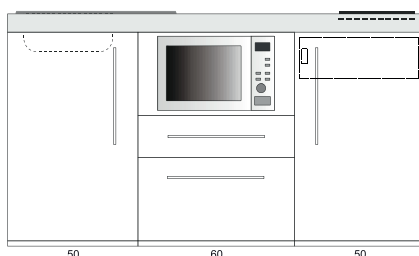

MPM 160

20l microwave
fridge
two drawers

dimensions: 160 x 60 x 89 cm (WxDxH)

| article no. | colour | hob | bowlside |
|-------------------|-----------|-----------|------------|
| 10160 809631 - XX | ceramic | ceramic | bowl right |
| 10160 809641 - XX | ceramic | ceramic | bowl left |
| 10160 809651 - XX | without | without | bowl right |
| 10160 809661 - XX | without | without | bowl left |
| 10160 809671 - XX | induction | induction | bowl right |
| 10160 809681 - XX | induction | induction | bowl left |

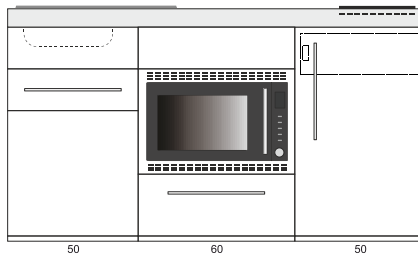

MPMOS 160

30l microwave /oven combination
fridge
under-sink cupboard with door and touch closure
two drawers

dimensions: 160 x 60 x 89 cm (WxDxH)

| article no. | colour | hob | bowlside |
|-------------------|-----------|-----------|------------|
| 10160 680631 - XX | ceramic | ceramic | bowl right |
| 10160 680641 - XX | ceramic | ceramic | bowl left |
| 10160 680651 - XX | without | without | bowl right |
| 10160 680661 - XX | without | without | bowl left |
| 10160 680671 - XX | induction | induction | bowl right |
| 10160 680681 - XX | induction | induction | bowl left |

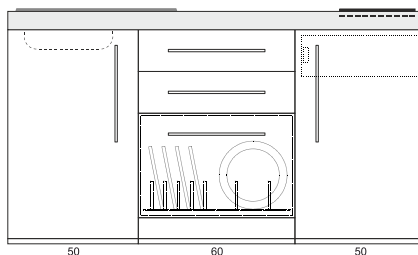

MPGS 160

dishwasher
fridge
two drawers

dimensions: 160 x 60 x 89 cm (WxDxH)

| article no. | colour | hob | bowlside |
|-------------------|-----------|-----------|------------|
| 10160 781631 - XX | ceramic | ceramic | bowl right |
| 10160 781641 - XX | ceramic | ceramic | bowl left |
| 10160 781651 - XX | without | without | bowl right |
| 10160 781661 - XX | without | without | bowl left |
| 10160 781671 - XX | induction | induction | bowl right |
| 10160 781681 - XX | induction | induction | bowl left |

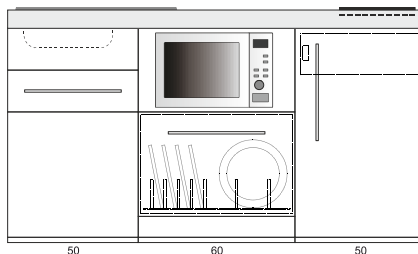

MPGSM 160

dishwasher
20l microwave
fridge
under-sink cupboard with door and touch closure
one drawer

dimensions: 160 x 60 x 89 cm (WxDxH)

| article no. | colour | hob | bowlside |
|-------------------|-----------|-----------|------------|
| 10160 783631 - XX | ceramic | ceramic | bowl right |
| 10160 783641 - XX | ceramic | ceramic | bowl left |
| 10160 783651 - XX | without | without | bowl right |
| 10160 783661 - XX | without | without | bowl left |
| 10160 783671 - XX | induction | induction | bowl right |
| 10160 783681 - XX | induction | induction | bowl left |

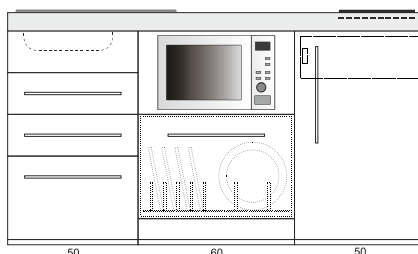

MPGSMS3 160

dishwasher
20l microwave
fridge
three drawers

dimensions: 160 x 60 x 89 cm (WxDxH)

| article no. | colour | hob | bowlside |
|-------------------|-----------|-----------|------------|
| 10160 150631 - XX | ceramic | ceramic | bowl right |
| 10160 150641 - XX | ceramic | ceramic | bowl left |
| 10160 150651 - XX | without | without | bowl right |
| 10160 150661 - XX | without | without | bowl left |
| 10160 150671 - XX | induction | induction | bowl right |
| 10160 150681 - XX | induction | induction | bowl left |

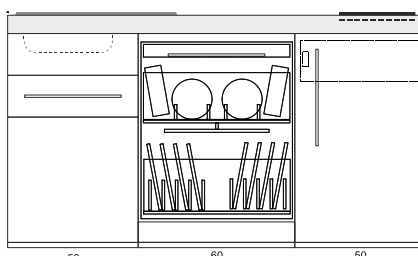

MPGG 160

big dishwasher - for 15 sets
under-sink cupboard with door and touch closure
fridge
one drawer

dimensions: 160 x 60 x 89 cm (WxDxH)

| article no. | colour | hob | bowlside |
|-------------------|-----------|-----------|------------|
| 10160 106631 - XX | ceramic | ceramic | bowl right |
| 10160 106641 - XX | ceramic | ceramic | bowl left |
| 10160 106651 - XX | without | without | bowl right |
| 10160 106661 - XX | without | without | bowl left |
| 10160 106671 - XX | induction | induction | bowl right |
| 10160 106681 - XX | induction | induction | bowl left |

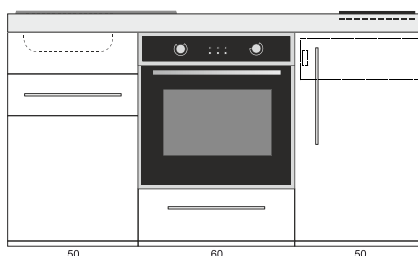

MPB 160

oven
fridge
under-sink cupboard with door and touch closure
two drawers

dimensions: 160 x 60 x 89 cm (WxDxH)



picture: MPB 170 - with hob

MINI KITCHEN PREMIUMLINE 170CM MP 170

- ◆ Fridge 4*-freezer (standard) or without fridge(*)
- ◆ Premium pantry top brushed and ground, built-in bowl Line 60, drain set and siphon, tap hole, with ceramic hob, induction hob or without hob
- ◆ Metal cupboard unit in white powder coated finish, cupboards have no back panels, drawers with softclose
- ◆ Filled double-walled fronts, powder-coated, bar handle in stainless steel
- ◆ Fridge with metal covered fridge door
- ◆ Working height 89 cm
- ◆ Inclusive all listed electrical appliances
- ◆ Available in eight different colours
- ◆ Delivered assembled and ready to plug in

Colour Range Premiumline

stainless steel



gloss powder coating

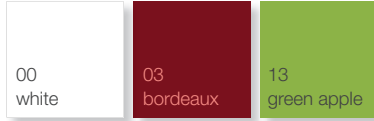

matt powder coating

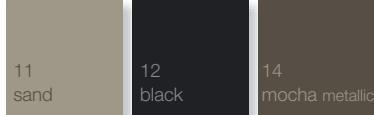

structure powder coating

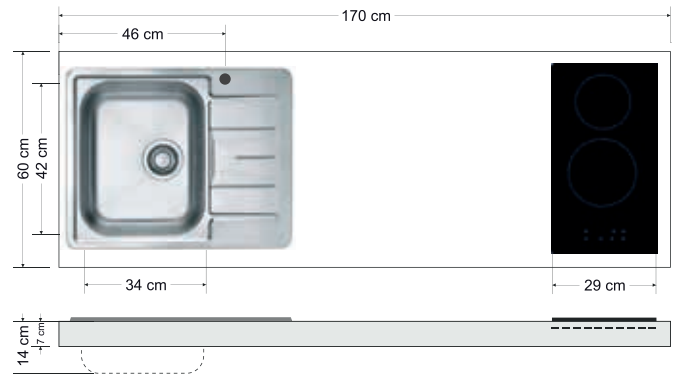
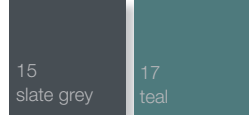

| article no. | colour | hob | bowlside |
|-------------------|--------|-----------|------------|
| 10170 080631 - XX | | ceramic | bowl right |
| 10170 080641 - XX | | ceramic | bowl left |
| 10170 080651 - XX | | without | bowl right |
| 10170 080661 - XX | | without | bowl left |
| 10170 080671 - XX | | induction | bowl right |
| 10170 080681 - XX | | induction | bowl left |

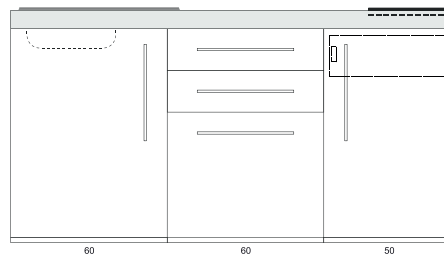

MP 170

fridge
two drawers

dimensions: 170 x 60 x 89 cm (WxDxH)

| article no. | colour | hob | bowlside |
|-------------------|--------|-----------|------------|
| 10170 030631 - XX | | ceramic | bowl right |
| 10170 030641 - XX | | ceramic | bowl left |
| 10170 030651 - XX | | without | bowl right |
| 10170 030661 - XX | | without | bowl left |
| 10170 030671 - XX | | induction | bowl right |
| 10170 030681 - XX | | induction | bowl left |

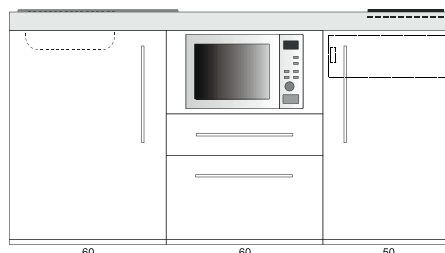

MPM 170

20l microwave
fridge
two drawers

dimensions: 170 x 60 x 89 cm (WxDxH)

| article no. | colour | hob | bowlside |
|-------------------|-----------|-----------|------------|
| 10170 809631 - XX | ceramic | ceramic | bowl right |
| 10170 809641 - XX | ceramic | ceramic | bowl left |
| 10170 809651 - XX | without | without | bowl right |
| 10170 809661 - XX | without | without | bowl left |
| 10170 809671 - XX | induction | induction | bowl right |
| 10170 809681 - XX | induction | induction | bowl left |

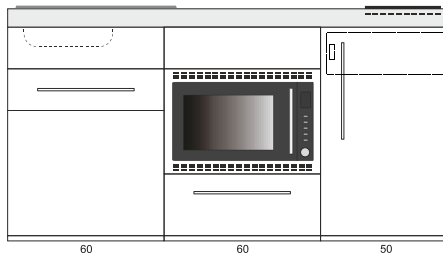

MPMOS 170

30l microwave /oven combination
fridge
under-sink cupboard with door and touch closure
two drawers

dimensions: 170 x 60 x 89 cm (WxDxH)

| article no. | colour | hob | bowlside |
|-------------------|-----------|-----------|------------|
| 10170 880631 - XX | ceramic | ceramic | bowl right |
| 10170 880641 - XX | ceramic | ceramic | bowl left |
| 10170 880651 - XX | without | without | bowl right |
| 10170 880661 - XX | without | without | bowl left |
| 10170 880671 - XX | induction | induction | bowl right |
| 10170 880681 - XX | induction | induction | bowl left |

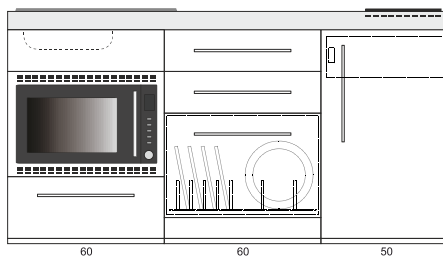

MPGSMOS 170

dishwasher
30l microwave /oven combination
fridge
three drawers

dimensions: 170 x 60 x 89 cm (WxDxH)

| article no. | colour | hob | bowlside |
|-------------------|-----------|-----------|------------|
| 10170 680631 - XX | ceramic | ceramic | bowl right |
| 10170 680641 - XX | ceramic | ceramic | bowl left |
| 10170 680651 - XX | without | without | bowl right |
| 10170 680661 - XX | without | without | bowl left |
| 10170 680671 - XX | induction | induction | bowl right |
| 10170 680681 - XX | induction | induction | bowl left |

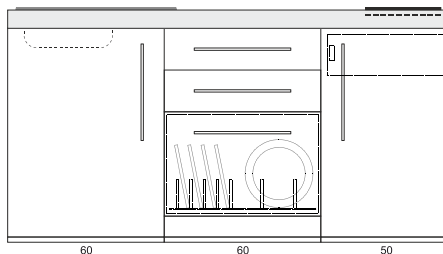

MPGS 170

dishwasher
fridge
two drawers

dimensions: 170 x 60 x 89 cm (WxDxH)

| article no. | colour | hob | bowlside |
|-------------------|-----------|-----------|------------|
| 10170 781631 - XX | ceramic | ceramic | bowl right |
| 10170 781641 - XX | ceramic | ceramic | bowl left |
| 10170 781651 - XX | without | without | bowl right |
| 10170 781661 - XX | without | without | bowl left |
| 10170 781671 - XX | induction | induction | bowl right |
| 10170 781681 - XX | induction | induction | bowl left |

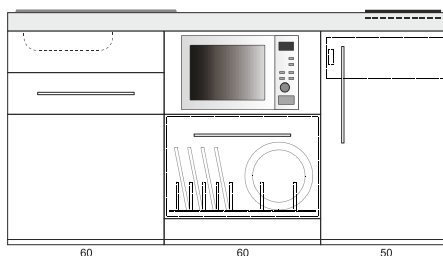

MPGSM 170

dishwasher
20l microwave
fridge
under-sink cupboard with door and touch closure
one drawer

dimensions: 170 x 60 x 89 cm (WxDxH)

| article no. | colour | hob | bowlside |
|-------------------|-----------|-----------|------------|
| 10170 150631 - XX | ceramic | ceramic | bowl right |
| 10170 150641 - XX | ceramic | ceramic | bowl left |
| 10170 150651 - XX | without | without | bowl right |
| 10170 150661 - XX | without | without | bowl left |
| 10170 150671 - XX | induction | induction | bowl right |
| 10170 150681 - XX | induction | induction | bowl left |

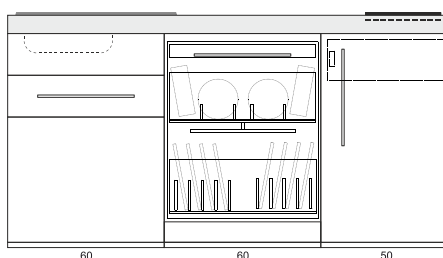

MPGG 170

big dishwasher - for 15 sets
under-sink cupboard with door and touch closure
one drawer

dimensions: 170 x 60 x 89 cm (WxDxH)

| article no. | colour | hob | bowlside |
|-------------------|-----------|-----------|------------|
| 10170 106631 - XX | ceramic | ceramic | bowl right |
| 10170 106641 - XX | ceramic | ceramic | bowl left |
| 10170 106651 - XX | without | without | bowl right |
| 10170 106661 - XX | without | without | bowl left |
| 10170 106671 - XX | induction | induction | bowl right |
| 10170 106681 - XX | induction | induction | bowl left |

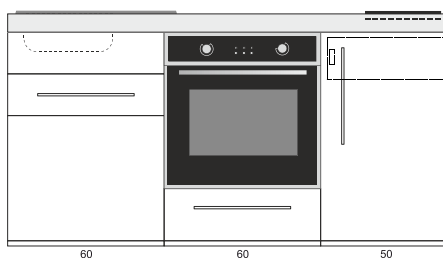

MPB 170

oven
fridge
under-sink cupboard with door and touch closure
two drawers

dimensions: 170 x 60 x 89 cm (WxDxH)



picture: MPM 180 A - with hob

MINI KITCHEN PREMIUMLINE 180CM 180CM

- ◆ Fridge 4*-freezer (standard) or without fridge(*)
- ◆ Premium pantry top brushed and ground, built-in bowl Line 60, drain set and siphon, tap hole, with ceramic hob, induction hob or without hob
- ◆ Metal cupboard unit in white powder coated finish, cupboards have no back panels, drawers with softclose
- ◆ Filled double-walled fronts, powder-coated, bar handle in stainless steel
- ◆ Fridge with metal covered fridge door
- ◆ Working height 89 cm
- ◆ Inclusive all listed electrical appliances
- ◆ Available in eight different colours
- ◆ Delivered assembled and ready to plug in

Colour Range Premiumline

stainless steel

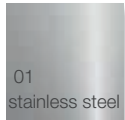

gloss powder coating

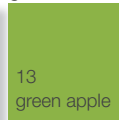
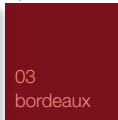
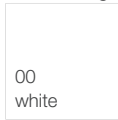

matt powder coating

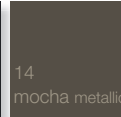
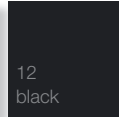

structure powder coating

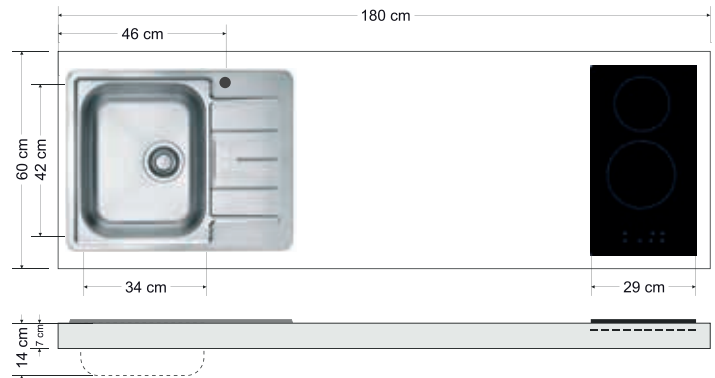
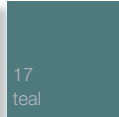
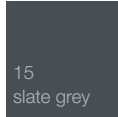

| article no. | colour | hob | bowlside |
|-------------------|--------|-----------|------------|
| 10180 082631 - XX | | ceramic | bowl right |
| 10180 082641 - XX | | ceramic | bowl left |
| 10180 082651 - XX | | without | bowl right |
| 10180 082661 - XX | | without | bowl left |
| 10180 082671 - XX | | induction | bowl right |
| 10180 082681 - XX | | induction | bowl left |

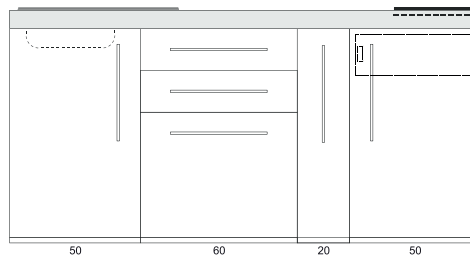

MP 180 A

fridge
pull out unit 20 cm with two trays
two drawers

dimensions: 180 x 60 x 89 cm (WxDxH)

| article no. | colour | hob | bowlside |
|-------------------|--------|-----------|------------|
| 10180 032631 - XX | | ceramic | bowl right |
| 10180 032641 - XX | | ceramic | bowl left |
| 10180 032651 - XX | | without | bowl right |
| 10180 032661 - XX | | without | bowl left |
| 10180 032671 - XX | | induction | bowl right |
| 10180 032681 - XX | | induction | bowl left |

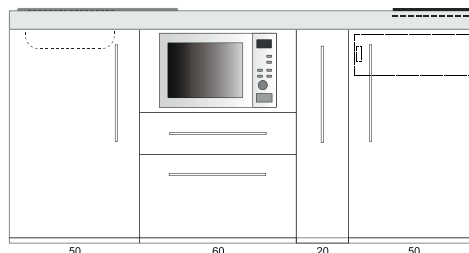

MPM 180 A

20l microwave
fridge
pull out unit 20 cm with two trays
two drawers

dimensions: 180 x 60 x 89 cm (WxDxH)

| article no. | colour | hob | bowlside |
|-------------------|--------|-----------|------------|
| 10180 809631 - XX | | ceramic | bowl right |
| 10180 809641 - XX | | ceramic | bowl left |
| 10180 809651 - XX | | without | bowl right |
| 10180 809661 - XX | | without | bowl left |
| 10180 809671 - XX | | induction | bowl right |
| 10180 809681 - XX | | induction | bowl left |

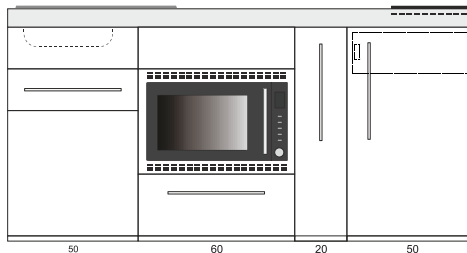

MPMOS 180 A

30l microwave /oven combination
fridge
pull out unit 20 cm with two trays
under-sink cupboard with door and touch closure
two drawers
dimensions: 180 x 60 x 89 cm (WxDxH)

| article no. | colour | hob | bowlside |
|-------------------|--------|-----------|------------|
| 10180 880631 - XX | | ceramic | bowl right |
| 10180 880641 - XX | | ceramic | bowl left |
| 10180 880651 - XX | | without | bowl right |
| 10180 880661 - XX | | without | bowl left |
| 10180 880671 - XX | | induction | bowl right |
| 10180 880681 - XX | | induction | bowl left |

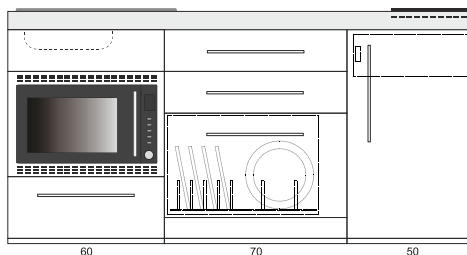

MPGSMOS 180

dishwasher
30l microwave /oven combination
fridge
three drawers
dimensions: 180 x 60 x 89 cm (WxDxH)

| article no. | colour | hob | bowlside |
|-------------------|--------|-----------|------------|
| 10180 682631 - XX | | ceramic | bowl right |
| 10180 682641 - XX | | ceramic | bowl left |
| 10180 682651 - XX | | without | bowl right |
| 10180 682661 - XX | | without | bowl left |
| 10180 682671 - XX | | induction | bowl right |
| 10180 682681 - XX | | induction | bowl left |

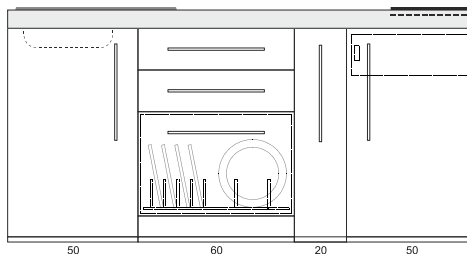

MPGS 180 A

dishwasher
fridge
pull out unit 20 cm with two trays
two drawers
dimensions: 180 x 60 x 89 cm (WxDxH)

| article no. | colour | hob | bowlside |
|-------------------|--------|-----------|------------|
| 10180 782631 - XX | | ceramic | bowl right |
| 10180 782641 - XX | | ceramic | bowl left |
| 10180 782651 - XX | | without | bowl right |
| 10180 782661 - XX | | without | bowl left |
| 10180 782671 - XX | | induction | bowl right |
| 10180 782681 - XX | | induction | bowl left |

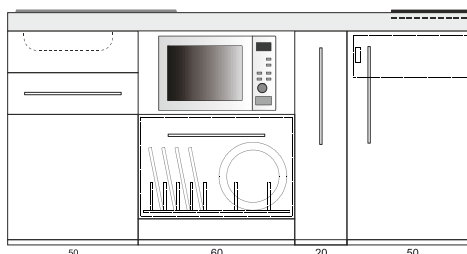

MPGSM 180 A

dishwasher
20l microwave
fridge
pull out unit 20 cm with two trays
under-sink cupboard with door and touch closure
one drawer
dimensions: 180 x 60 x 89 cm (WxDxH)

| article no. | colour | hob | bowlside |
|-------------------|--------|-----------|------------|
| 10180 152631 - XX | | ceramic | bowl right |
| 10180 152641 - XX | | ceramic | bowl left |
| 10180 152651 - XX | | without | bowl right |
| 10180 152661 - XX | | without | bowl left |
| 10180 152671 - XX | | induction | bowl right |
| 10180 152681 - XX | | induction | bowl left |

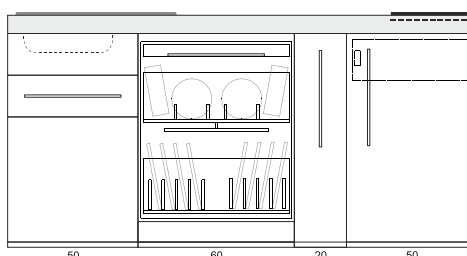

MPGG 180 A

big dishwasher - for 15 sets
fridge
pull out unit 20 cm with two trays
under-sink cupboard with door and touch closure
one drawer
dimensions: 180 x 60 x 89 cm (WxDxH)

| article no. | colour | hob | bowlside |
|-------------------|--------|-----------|------------|
| 10180 162631 - XX | | ceramic | bowl right |
| 10180 162641 - XX | | ceramic | bowl left |
| 10180 162651 - XX | | without | bowl right |
| 10180 162661 - XX | | without | bowl left |
| 10180 162671 - XX | | induction | bowl right |
| 10180 162681 - XX | | induction | bowl left |

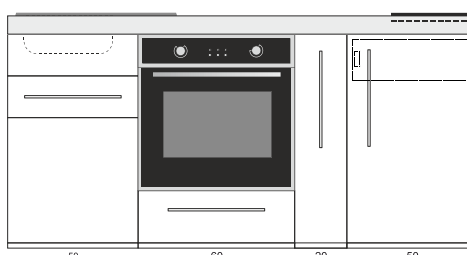

MPB 180 A

oven
fridge
pull out unit 20 cm with two trays
under-sink cupboard with door and touch closure
two drawers
dimensions: 180 x 60 x 89 cm (WxDxH)

MK KITCHENLINE

MINI KITCHEN

COMPACT AND PERFECT - OUR ENTRY KITCHEN
MADE OF METAL AND FINISHED IN POWDER
COATED STEEL

If you are looking for quality for a small price then a **Stengel Kitchenline** is made for you. Sink, hotplates, fridge, storage space, microwave, oven - all compact and in one **mini kitchen**.

Kitchenline is made of powder coated metal and is equipped with insulated, double-walled doors. **Kitchenline** is available in four widths 90, 100, 120 and 150 cm.

Please discover the many combinations on the following pages.





picture: MKB150 with hob and wall cupboard in colour sand

MK KITCHENLINE IN COLOUR

FANCY SOME COLOUR?

Our new modern colors give you the opportunity to set accents or a fresh splash of color with your mini kitchen.

With colour on all visible sides, our **mini kitchen** is also a highlight of your interior. Metal and stainless steel can also provide a decorative contrast to natural materials such as wood.

You are spoiled for choice: matt or glossy, in the colors sand, mocha, black or red...





Kitchenline MK

GREEN APPLE

picture: MKM120 A with hob and wall cupboard

MODELS

MINI KITCHEN MK KITCHENLINE



MK 90
see page 37



MK 120
see page 39



MK 150
see page 41



MK 100
see page 37



MK 120 A
see page 39



MKM 150
see page 41



MKM 100
see page 37



MKM 120
see page 39



MKB 150
see page 41



MKB 100
see page 37



MKM 120 A
see page 39



Kitchenline MK

picture: MK90 with hob in colour white



picture: MK 100 - with electric hotplates

MINI KITCHEN KITCHENLINE 90-100CM MK 90 - 100

- ◆ Fridge 4*-freezer (standard) or without fridge(*)
- ◆ Pantry top in stainless steel, hob controls on the front, bowl, drain set, 35mm hole for tap, choice of solid hotplates, ceramic hob or without hob
- ◆ Metal cupboard unit in white powder coated finish, cupboards have no back panels
- ◆ Filled double-walled fronts, powder-coated, standard handle
- ◆ Kitchen in colour white: There is a slight colour difference between fridge front and base structure
- ◆ Working height 89 cm
- ◆ Inclusive all listed electrical appliances
- ◆ Available in six different colours
- ◆ Delivered assembled and ready to plug in

Top version



electric hotplates



ceramic hobs



without hotplates

Colour Range Kitchenline

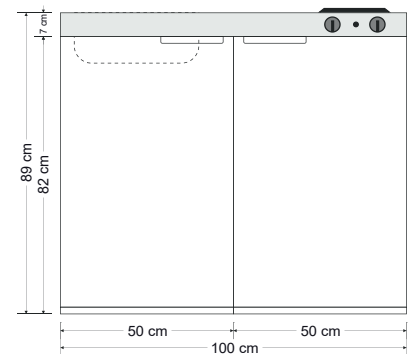
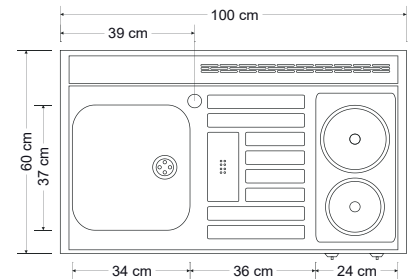

| article no. | colour | hob | bowlside |
|-------------------|--------|----------|------------|
| 11090 000011 - XX | | electric | bowl right |
| 11090 000021 - XX | | electric | bowl left |
| 11090 000031 - XX | | ceramic | bowl right |
| 11090 000041 - XX | | ceramic | bowl left |
| 11090 000051 - XX | | without | bowl right |
| 11090 000061 - XX | | without | bowl left |

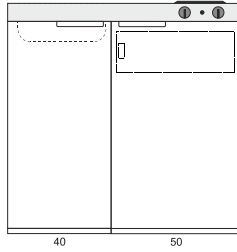

MK 90

fridge

dimensions: 90 x 60 x 89 cm (WxDxH)

| article no. | colour | hob | bowlside |
|-------------------|--------|----------|------------|
| 11100 000011 - XX | | electric | bowl right |
| 11100 000021 - XX | | electric | bowl left |
| 11100 000031 - XX | | ceramic | bowl right |
| 11100 000041 - XX | | ceramic | bowl left |
| 11100 000051 - XX | | without | bowl right |
| 11100 000061 - XX | | without | bowl left |

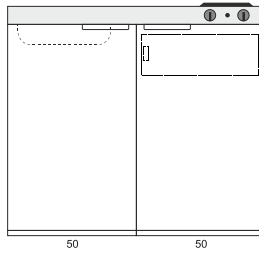

MK 100

fridge

dimensions: 100 x 60 x 89 cm (WxDxH)

| article no. | colour | hob | bowlside |
|-------------------|--------|----------|------------|
| 11100 010011 - XX | | electric | bowl right |
| 11100 010021 - XX | | electric | bowl left |
| 11100 010031 - XX | | ceramic | bowl right |
| 11100 010041 - XX | | ceramic | bowl left |
| 11100 010051 - XX | | without | bowl right |
| 11100 010061 - XX | | without | bowl left |

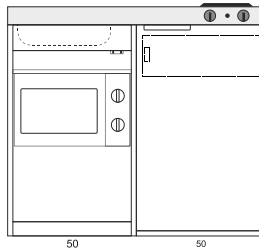

MKM 100

microwave, located behind the door
fridge

dimensions: 180 x 60 x 89 cm (WxDxH)

| article no. | colour | hob | bowlside |
|-------------------|--------|----------|------------|
| 11100 006011 - XX | | electric | bowl right |
| 11100 006021 - XX | | electric | bowl left |
| 11100 006031 - XX | | ceramic | bowl right |
| 11100 006041 - XX | | ceramic | bowl left |
| 11100 006051 - XX | | without | bowl right |
| 11100 006061 - XX | | without | bowl left |

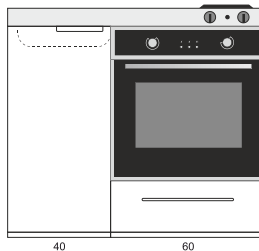

MKB 100

oven
cupboard 40cm, without fridge
one drawer

dimensions: 100 x 60 x 89 cm (WxDxH)



picture: MKM 120 A - with ceramic hobs

MINI KITCHEN KITCHENLINE 120CM MK 120

- ◆ Fridge 4*-freezer (standard) or without fridge(*)
- ◆ Pantry top in stainless steel, hob controls on the front, bowl, drain set, 35mm hole for tap, choice of solid hotplates, ceramic hob or without hob
- ◆ Metal cupboard unit in white powder coated finish, cupboards have no back panels
- ◆ Filled double-walled fronts, powder-coated, standard handle
- ◆ Kitchen in colour white: There is a slight colour difference between fridge front and base structur
- ◆ Working height 89 cm
- ◆ Inclusive all listed electrical appliances
- ◆ Available in six different colours
- ◆ Delivered assembled and ready to plug in

Top version



electric hotplates



ceramic hobs



without hotplates

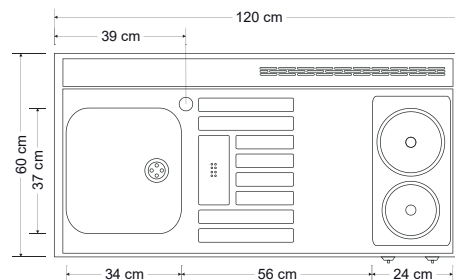

Colour Range Kitchenline

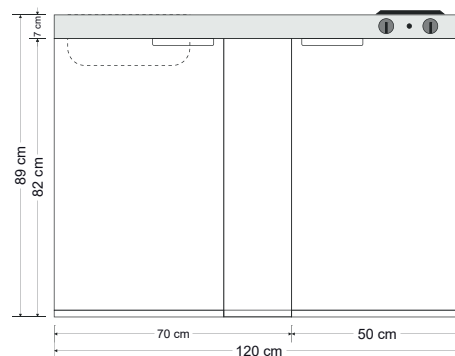
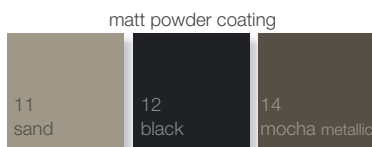

| article no. | colour | hob | bowlside |
|-------------------|--------|----------|------------|
| 11120 001011 - XX | | electric | bowl right |
| 11120 001021 - XX | | electric | bowl left |
| 11120 001031 - XX | | ceramic | bowl right |
| 11120 001041 - XX | | ceramic | bowl left |
| 11120 001051 - XX | | without | bowl right |
| 11120 001061 - XX | | without | bowl left |

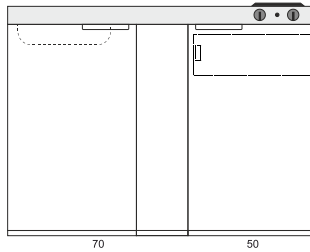

MK 120

fridge
2-door cupboard 50/20cm

dimensions: 120 x 60 x 89 cm (WxDxH)

| article no. | colour | hob | bowlside |
|-------------------|--------|----------|------------|
| 11120 002011 - XX | | electric | bowl right |
| 11120 002021 - XX | | electric | bowl left |
| 11120 002031 - XX | | ceramic | bowl right |
| 11120 002041 - XX | | ceramic | bowl left |
| 11120 002051 - XX | | without | bowl right |
| 11120 002061 - XX | | without | bowl left |

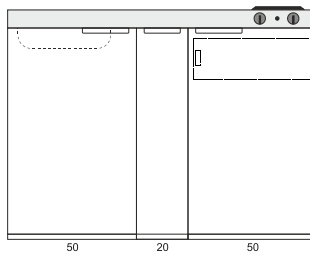

MK 120 A

fridge
pull out unit 20 cm with two trays

dimensions: 120 x 60 x 89 cm (WxDxH)

| article no. | colour | hob | bowlside |
|-------------------|--------|----------|------------|
| 11120 011011 - XX | | electric | bowl right |
| 11120 011021 - XX | | electric | bowl left |
| 11120 011031 - XX | | ceramic | bowl right |
| 11120 011041 - XX | | ceramic | bowl left |
| 11120 011051 - XX | | without | bowl right |
| 11120 011061 - XX | | without | bowl left |

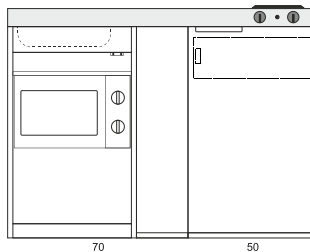

MKM 120

microwave, located behind the door
fridge
2-door cupboard 50/20cm

dimensions: 120 x 60 x 89 cm (WxDxH)

| article no. | colour | hob | bowlside |
|-------------------|--------|----------|------------|
| 11120 012011 - XX | | electric | bowl right |
| 11120 012021 - XX | | electric | bowl left |
| 11120 012031 - XX | | ceramic | bowl right |
| 11120 012041 - XX | | ceramic | bowl left |
| 11120 012051 - XX | | without | bowl right |
| 11120 012061 - XX | | without | bowl left |

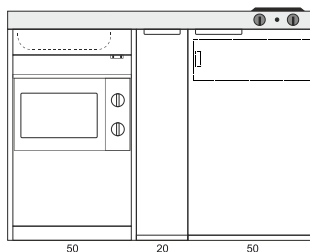

MKM 120 A

microwave, located behind the door
fridge
pull out unit 20 cm with two trays

dimensions: 120 x 60 x 89 cm (WxDxH)



picture: MKB 150 - without hobplates

MINI KITCHEN KITCHENLINE 150CM MK 150

- ◆ Fridge 4*-freezer (standard) or without fridge(*)
- ◆ Pantry top in stainless steel, hob controls on the front, bowl, drain set, 35mm hole for tap, choice of solid hotplates, ceramic hob or without hob
- ◆ Metal cupboard unit in white powder coated finish, cupboards have no back panels
- ◆ Filled double-walled fronts, powder-coated, standard handle
- ◆ Kitchen in colour white: There is a slight colour difference between fridge front and base structur
- ◆ Working height 89 cm
- ◆ Inclusive all listed electrical appliances
- ◆ Available in six different colours
- ◆ Delivered assembled and ready to plug in

Top version



electric hotplates



ceramic hobs



without hotplates

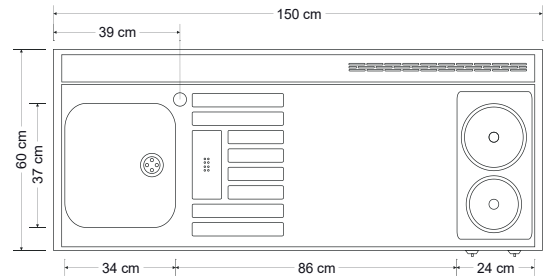

Colour Range Kitchenline

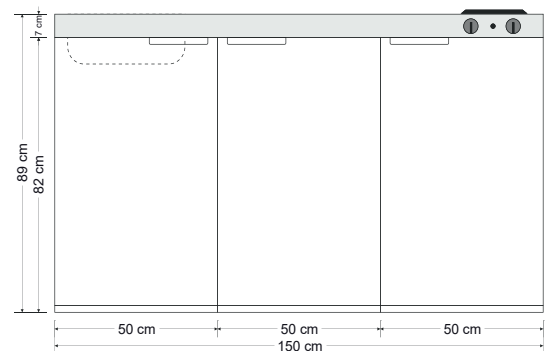

| article no. | colour | hob | bowlside |
|-------------------|--------|----------|------------|
| 11150 000011 - XX | | electric | bowl right |
| 11150 000021 - XX | | electric | bowl left |
| 11150 000031 - XX | | ceramic | bowl right |
| 11150 000041 - XX | | ceramic | bowl left |
| 11150 000051 - XX | | without | bowl right |
| 11150 000061 - XX | | without | bowl left |

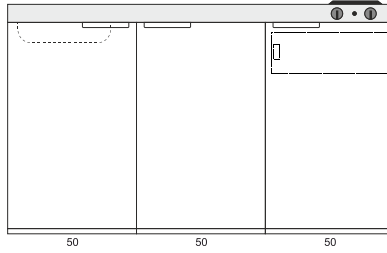

MK 150

fridge

dimensions: 150 x 60 x 89 cm (WxDxH)

| article no. | colour | hob | bowlside |
|-------------------|--------|----------|------------|
| 11150 010011 - XX | | electric | bowl right |
| 11150 010021 - XX | | electric | bowl left |
| 11150 010031 - XX | | ceramic | bowl right |
| 11150 010041 - XX | | ceramic | bowl left |
| 11150 010051 - XX | | without | bowl right |
| 11150 010061 - XX | | without | bowl left |

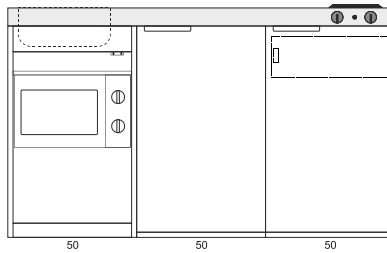

MKM 150

microwave, located behind the door
fridge

dimensions: 150 x 60 x 89 cm (WxDxH)

| article no. | colour | hob | bowlside |
|-------------------|--------|----------|------------|
| 11150 006011 - XX | | electric | bowl right |
| 11150 006021 - XX | | electric | bowl left |
| 11150 006031 - XX | | ceramic | bowl right |
| 11150 006041 - XX | | ceramic | bowl left |
| 11150 006051 - XX | | without | bowl right |
| 11150 006061 - XX | | without | bowl left |

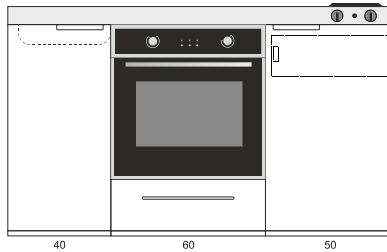

MKB 150

oven
fridge
one drawer

dimensions: 150 x 60 x 89 cm (WxDxH)

ME EASYLINE MINI KITCHEN

EASY AND FUNCTIONAL -
OUR ME EASYLINE

If less is more for you, then look no further.

The Easyline models offer impressive **Stengel** quality at an affordable price. All the essential requirements - refrigeration, dishwashing and cooking - are met.

The **mini kitchen** made of powder-coated steel features double-walled doors with push opening.





Easyline ME

picture: ME100 with wall cupboard

MINI KITCHEN EASYLINE 100CM ME 100

- ◆ Fridge 48cm wide - 4* -freezer
- ◆ Pantry top in stainless steel, hob controls on the front, bowl, drain set, 35mm hole for tap, a choice of solid hotplates or without hob
- ◆ Metal cupboard 520mm unit in white powder coated finish. Door without handle - touch closure
- ◆ There is a slight colour difference between fridge front and base structur
- ◆ Working height 89 cm
- ◆ Available only in colour white
- ◆ Available only including fridge
- ◆ Delivered assembled and ready to plug in



picture: ME 100 - with electric hotplates

ME 100

fridge

| article no. | hob | bowlside |
|-----------------|----------|------------|
| 14100 000013 00 | electric | bowl right |
| 14100 000023 00 | electric | bowl left |
| 14100 000053 00 | without | bowl right |
| 14100 000063 00 | without | bowl left |

dimensions: 100 x 60 x 89 cm (WxDxH)

Top version

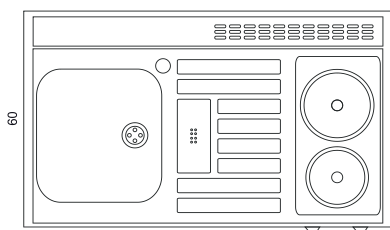

electric hotplates



without hotplates

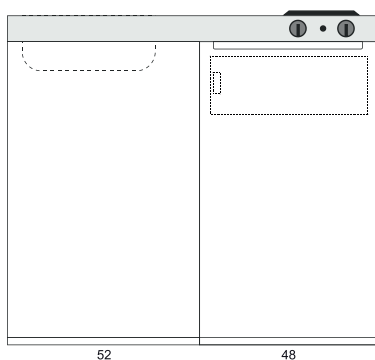

MINI KITCHEN EASYLINE 120CM ME 120

- ◆ Fridge 48cm wide - 4*-freezer
- ◆ Pantry top in stainless steel, hob controls on the front, bowl, drain set, 35mm hole for tap, a choice of solid hotplates or without hob
- ◆ Metal cupboard 720mm unit with pelmet 200mm in white powder coated finish. Door without handle - touch closure
- ◆ There is a slight colour difference between fridge front and base structur
- ◆ Working height 89 cm
- ◆ Available only in colour white
- ◆ Available only including fridge
- ◆ Delivered assembled and ready to plug in



picture: ME 120 - without hotplates

ME 120

fridge
cupboard 72cm with fix pelmet

dimensions: 120 x 60 x 89 cm (WxDxH)

| article no. | hob | bowlside |
|-----------------|----------|------------|
| 14120 000013 00 | electric | bowl right |
| 14120 000023 00 | electric | bowl left |
| 14120 000053 00 | without | bowl right |
| 14120 000063 00 | without | bowl left |

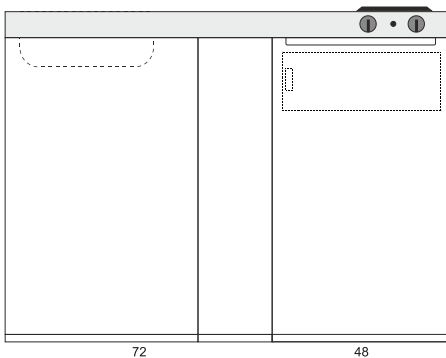
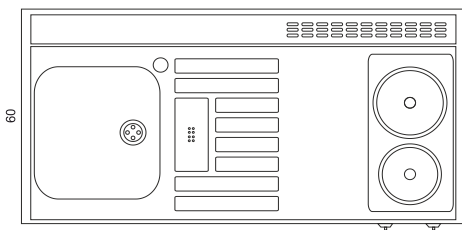

SL STUDIOLINE SET

Are you looking for something unique?

Would you like your **kitchen** free standing in a room?

The **Stengel Studioline** set offers a **mini kitchen** that meets all of these requirements.

We have developed the smallest **kitchen** with all functions and details that everyone needs and fits into the tightest of spaces.

A FREE STANDING MODULAR KITCHEN

Studioline is an ingenious system that links wall cupboards, splash backs and side panels to your chosen mini kitchen. The **Studioline** set gives you a complete kitchen solution that is compact, sleek and simple to install.





StudioLine SL

picture: SLD120 with MPM120A in colour white

STUDIOLINE

MODELS - H2060

SLD - H2060 - height 206cm

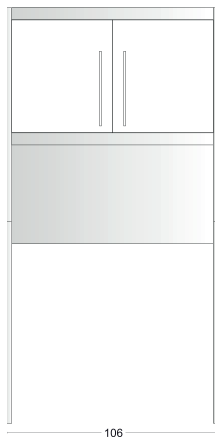
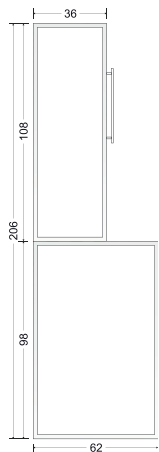

SLD 100 - H2060

article-no. 13100 000000 - XX

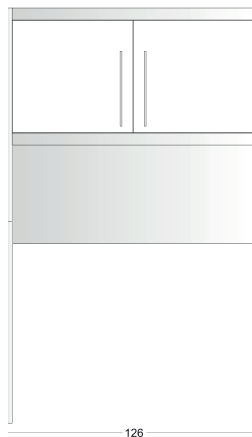

SLD 120 - H2060

13120 000000 - XX



SLD 150 - H2060

13150 000000 - XX

Colour Range Studioline

gloss powder coating

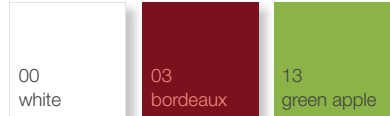

matt powder coating

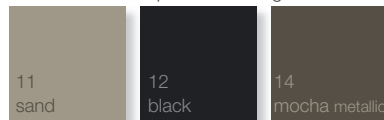

structure powder coating

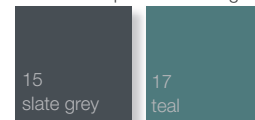

Modular system Studioline

- choose your mini kitchen to go with your selected Studioline

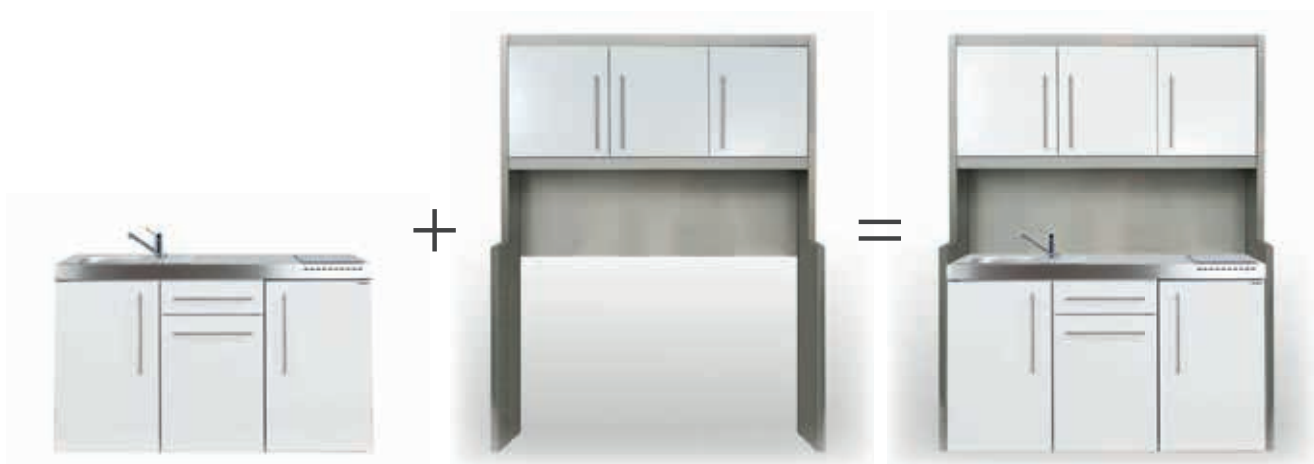

MODELS - H2220

SLD - H2220 - height 222cm

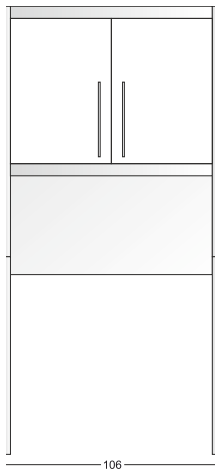
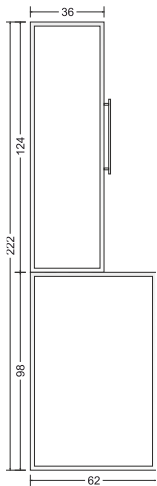

SLD 100 - H2220

article-no. 13100 005000 - XX

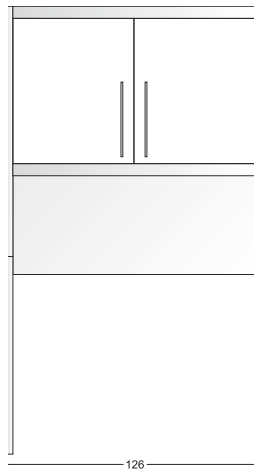

SLD 120 - H2220

13120 005000 - XX

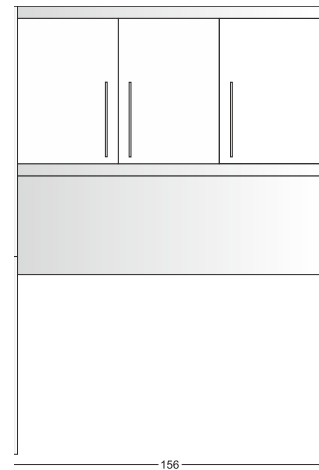

SLD 150 - H2220

13150 005000 - XX

SLDH - H2220 - with extractor hood (DH) - height 222cm

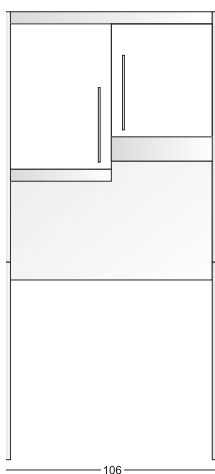
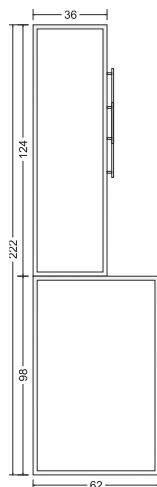

SLDH 100 - H2220

article-no. 13100 106000 - XX - extractor-right

article-no. 13100 206000 - XX - extractor-left

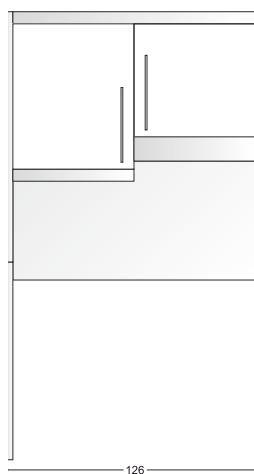

SLDH 120 - H2220

13120 106000 - XX - extractor-right

13120 206000 - XX - extractor-left

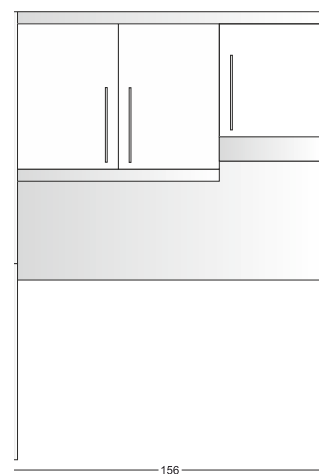

SLDH 150 - H2220

13150 106000 - XX - extractor-right

13150 206000 - XX - extractor-left

SLD STUDIOLINE H2060 - H2220

- ◆ Available in height of 206 cm und 222 cm
- ◆ Double sided frame made from brushed stainless steel 1.4301, white powder coated infill panels
- ◆ Self-supporting construction
- ◆ Splashback made from brushed stainless steel 1.4301
- ◆ Wall cupboard finished in powder coated metal, Filled double-walled fronts, powder-coated, bar handle in stainless steel in height 56 cm and 72 cm
- ◆ Upper and lower pelmets made from brushed stainless steel 1.4301
- ◆ Available in 106, 126 and 156 cm width (for 100,120 and 150 mini kitchens)
- ◆ Available in eight different colours
- ◆ Only available in combination with a matching minikitchen from the MP Premiumine
- ◆ Delivered in partially assembled condition with installation instruction



Colour Range Studioline

gloss powder coating

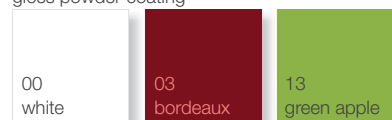

matt powder coating

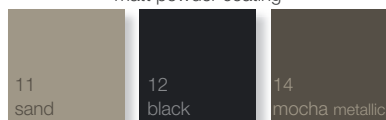

structure powder coating





Studio line SL

picture: SLD150 with MP150
in colour mocha metallic

SLDH STUDIOLINE H2220 - WITH EXTRACTOR HOOD

- ◆ Available in height 222 cm
- ◆ Double sided frame made from brushed stainless steel 1.4301, white powder coated infill panels
- ◆ Self-supporting construction
- ◆ Including extractor hood
- ◆ Splashback made from brushed stainless steel 1.4301
- ◆ Wall cupboard finished in powder coated metal, Filled double-walled fronts, powder-coated, bar handle in stainless steel in height 56 cm and 72 cm
- ◆ Upper and lower pelmets made from brushed stainless steel 1.4301
- ◆ Available in 106, 126 and 156 cm width (for 100, 120 and 150 mini kitchens)
- ◆ Available in eight different colours
- ◆ Only available in combination with a matching minikitchen from the MP Premiumine range
- ◆ Delivered in partially assembled condition with installation instruction





picture: SLDH150 with MPGS150
in colour sand

Studio line SL



SKM METAL CUPBOARD KITCHEN

STENDEL METALLIC CUPBOARD KITCHENS

Due to its contemporary design, our **Stengel Cupboard Kitchen** harmonically embeds itself into every environment.

The cupboard kitchen offers all the benefits of a **Stengel metal kitchen** plus longevity of life compared to a wooden kitchen.

Equip your basic model with electrical appliances and accessories that meet your demands. Easy-to-assemble and thus quickly ready for use.

...OPEN OR CLOSED

- METAL WITH A LOT OF STYLE AND CHARM

On the following pages you can customise your kitchen to suit your own personal preferences.





picture: SKM120 - with larder cupboard in colour slate grey

Cupboard kitchen

CUPBOARD KITCHEN

SKM 120 - BASIC MODEL

- ♦ Metal cupboard unit in white powder coated finish
- ♦ Double-walled doors and side parts with premium filling, bar handles in matt stainless steel
- ♦ Doors with magnetic closures and safety shut-off for hob
- ♦ Pantry top in stainless steel, including built-in bowl, drain set, 35mm hole for tap, a choice ceramic hob, induction hob or without hob
- ♦ Heat dissipation of the electrical appliances is ensured by a ventilation level provided between the wall and the rear panel
- ♦ Metal lower cupboard with drawer, compartment shelf and storage tray, depending on design and equipment
- ♦ Two shelves, 1x fixed, 1x height-adjustable
- ♦ Height-adjustable feet
- ♦ Only available in colour white and slate grey
- ♦ Delivered assembled and ready to plug in



picture: SKM120 with - fully equipped

Please find advice for the connection of the SKM on page 90

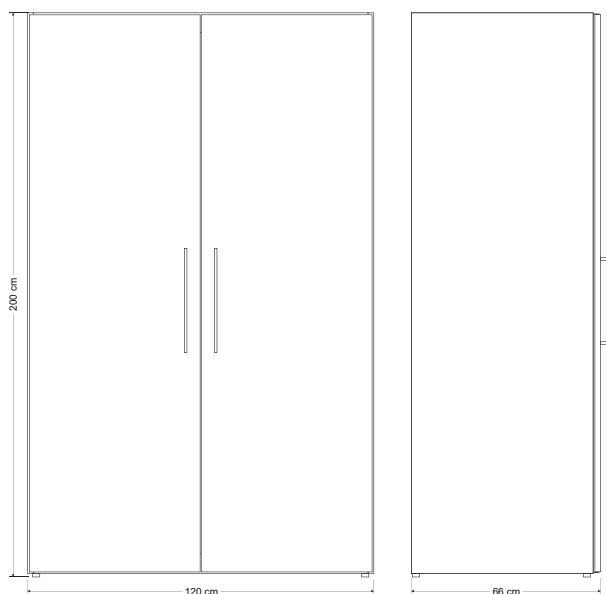

drawing: SKM 120 - measures

SKM 120 Basic model

cupboard, cabinet doors, 2x shelves, electrical outlet at the top, pantry top, under-sink cupboard with drawer and door, cupboard unit with door and compartment shelf
dimensions: W x D x H 120 x 66 x 200 cm

| article no. | hob | bowlside |
|-----------------|-----------|------------|
| 15120 000030 00 | ceramic | bowl right |
| 15120 000040 00 | ceramic | bowl left |
| 15120 000050 00 | without | bowl right |
| 15120 000060 00 | without | bowl left |
| 15120 000070 00 | induction | bowl right |
| 15120 000080 00 | induction | bowl left |

Colour Range Cupboard Kitchen

gloss
powder coating



matt
powder coating

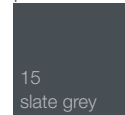



picture: SKM120 white - with lader cupboard

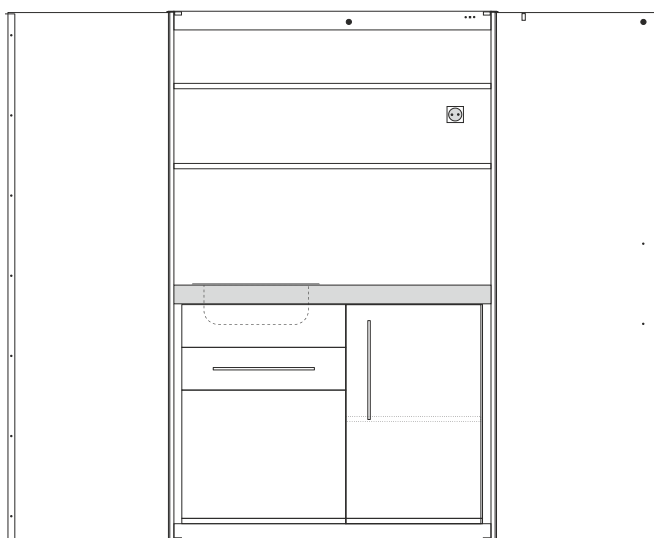

drawing: SKM 120 - Basic model without appliances

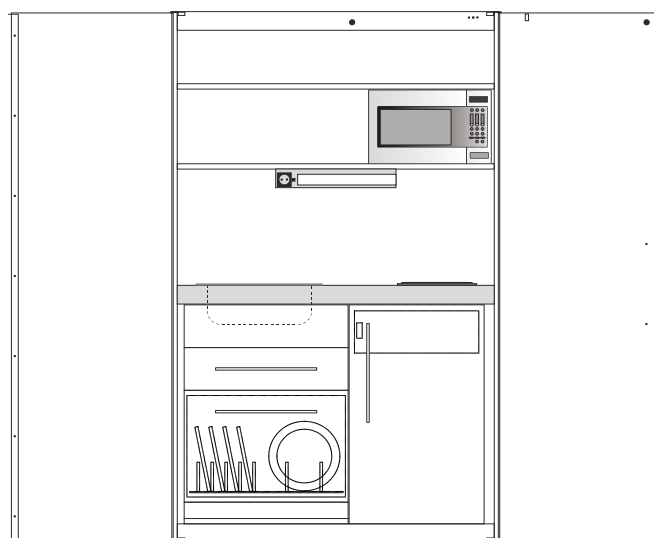

drawing: SKM 120 - Basic model - fully equipped

CUPBOARD KITCHEN

SKM 120 - ACCESSORIES

Equip your cupboard kitchen with electrical appliances and accessories of your choice.

Please find additional information about the accessories from page 76 onwards.

SKM 120

Accessories

| article no. | description |
|-----------------|---|
| 15000 900001 00 | fridge, 4* freezer, incl. mounting kit |
| 15000 910000 00 | dish-washer Stengel GS6-6F12 - integrated, incl. mounting kit |
| 15000 960000 00 | microwave Stengel STCOMBI 102, incl. mounting kit |
| 15000 950000 00 | light strip LED 56cm - aluminum/stainless steel, with electrical outlets, installed |
| 69001 000000 07 | waste bin Cube 50 14+18 litre (not possible in combination with dishwasher!) |
| 69005 000000 01 | drawer 60 - Excellent II 600/50 - grey |
| 60014 000000 00 | one-handle mixer Kludi Scope - high pressure - chrome |





picture: SKMG - larder cupboard 60cm - white

CUPBOARD KITCHEN

SKMG 60 - LARDER CUPBOARD

- ◆ Suitable to our Stengel Cupboard Kitchen metal
- ◆ Metal cupboard unit in white powder coated finish
- ◆ Filled double-walled fronts and sides, powder-coated, bar handle in stainless steel
- ◆ Five shelves, one fixed shelf and four adjustable shelves
- ◆ Available only in white
- ◆ Including wall panels 6 x 200cm
- ◆ Delivered assembled

SKMG 60

Larder cupboard

dimensions - 60 x 60 x 200 cm (WxDxH)

article no.

description

| | |
|-----------------|-------------------------------|
| 15060 100001 00 | door hinge right - white |
| 15060 200001 00 | door hinge left - white |
| 15060 100001 15 | door hinge right - slate grey |
| 15060 200001 15 | door hinge left - slate grey |

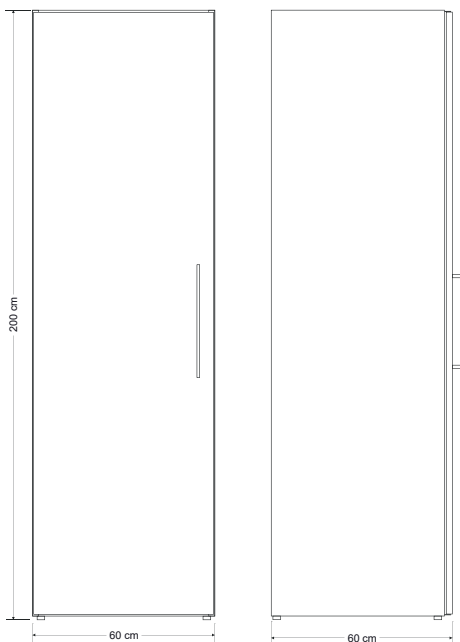

drawing: SKMG - larder cupboard 60cm

Colour Range Cupboard Kitchen

gloss
powder coating

matt
powder coating

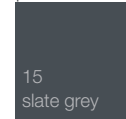
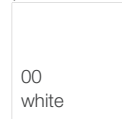

HS WALL CUPBOARDS METAL

**OUR WALL CUPBOARDS - THE PERFECT
ADDITION TO COMPLIMENT YOUR
MINI KITCHEN**

Premium with bar handle and Classic with hidden handle.

Increase the storage space in your kitchen by buying a wall cupboard to match the size and style of kitchen specified.

The doors are double walled with insulation to give strength and a solid feel and the carcass made of powder coated metal. Every wall cupboard is delivered pre-built.

Wall units are available in 560mm and 720mm height and supplied with one or two height-adjustable shelves. We provide a mounting rail for easy installation.

Our standard wall cupboards are available in white, stainless steel and in colour.

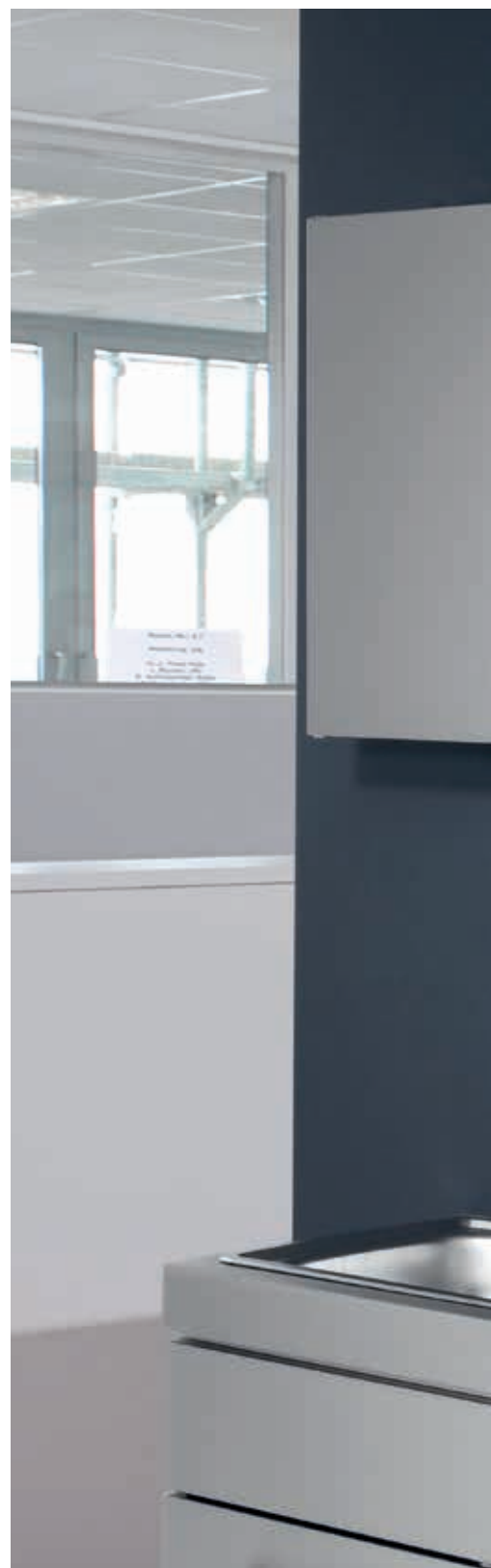



Cupboards

WALL CUPBOARDS METAL

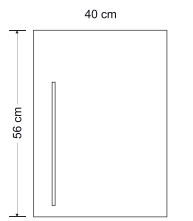

HS 40 - drawing

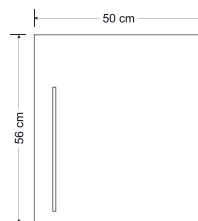

HS 50 - drawing

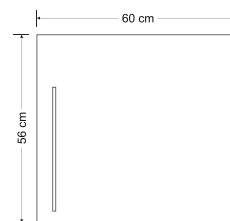

HS 60 - drawing

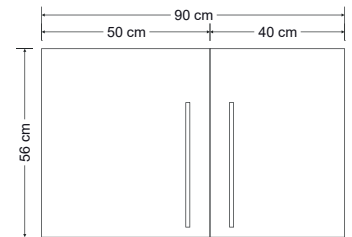

HS 90 - drawing



HS 40 - offen



HS 50 - open



HS 60 - open



HS 90 - open

HSPL - Premium

BAR HANDLE

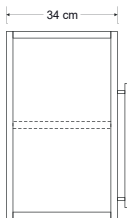

HSPL 40

article no. 30040 100001 - XX (DHR)

article no. 30040 200001 - XX (DHL)



HSPL 50

30050 100001 - XX (DHR)

30050 200001 - XX (DHL)



HSPL 60

30060 100001 - XX (DHR)

30060 200001 - XX (DHL)



HSPL 90

30090 100001 - XX (door 40cm DHR)

30090 200001 - XX (door 40cm DHL)

DHL = door hinge left - DHR = door hinge right

HSCL - Classic

HIDDEN HANDLE

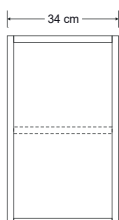

HSCL 40

article no. 30040 100002 - XX (DHR)

article no. 30040 200002 - XX (DHL)



HSCL 50

30050 100002 - XX (DHR)

30050 200002 - XX (DHL)



HSCL 60

30060 100002 - XX (DHR)

30060 200002 - XX (DHL)



HSCL 90

30090 100002 - XX (door 40cm DHR)

30090 200002 - XX (door 40cm DHL)

DHL = door hinge left - DHR = door hinge right

MODELS - H560

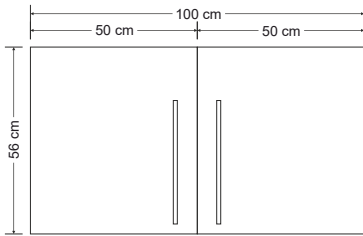

HS 100 - drawing

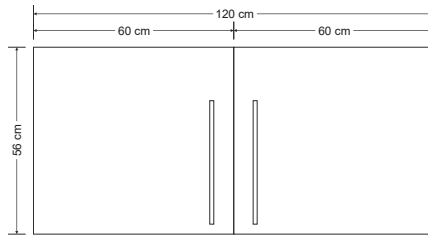

HS 120 - drawing

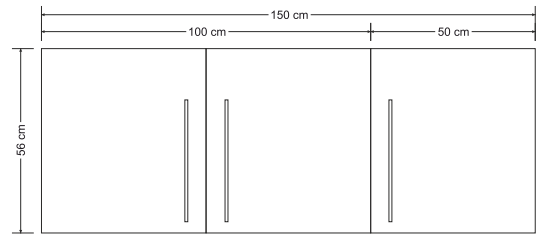

HS 150 - drawing



HS 100 - open



HS 120 - open



HS 150 - open

HSPL - Premium

BAR HANDLE



HSPL 100

article no. 30100 000001 - XX

article no.



HSPL 120

article no. 30120 000001 - XX



HSPL 150

article no. 30150 100001 - XX - 100/50 cm

article no. 30150 200001 - XX - 50/100 cm

HSCL - Classic

HIDDEN HANDLE



HSCL 100

article no. 30100 000002 - XX

article no.



HSCL 120

article no. 30120 000002 - XX



HSCL 150

article no. 30150 100002 - XX - 100/50 cm

article no. 30150 200002 - XX - 50/100 cm

WALL CUPBOARDS METAL

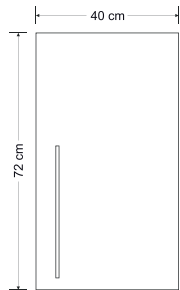

HS 40 - drawing

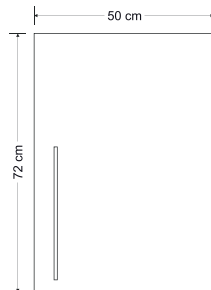

HS 50 - drawing

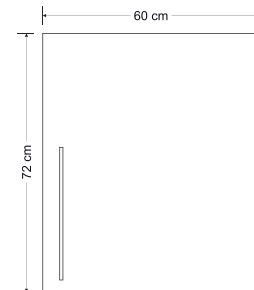

HS 60 - drawing



HS 40 - open



HS 50 - open



HS 60 - open

HSPL - Premium

BAR HANDLE

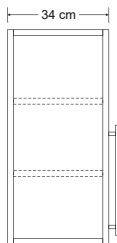

HSPL 40

article no. 30040 100101 - XX (DHR)
article no. 30040 200101 - XX (DHL)



HSPL 50

30050 100101 - XX (DHR)
30050 200101 - XX (DHL)



HSPL 60

30060 100101 - XX (DHR)
30060 200101 - XX (DHL)

DHL = door hinge left - DHR = door hinge right

HSCL - Classic

HIDDEN HANDLE

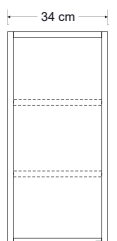

HSCL 40

article no. 30040 100102 - XX (DHR)
article no. 30040 200102 - XX (DHL)



HSCL 50

30050 100102 - XX (DHR)
30050 200102 - XX (DHL)



HSCL 60

30060 100102 - XX (DHR)
30060 200102 - XX (DHL)

DHL = door hinge left - DHR = door hinge right

MODELS - H720

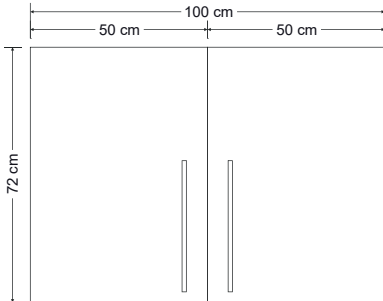

HS 100 - drawing

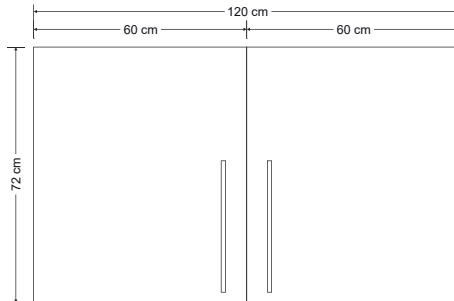

HS 120 - drawing



HS 100 - open



HS 120 - open

HSPL - Premium

BAR HANDLE



HSPL 100

article no. 30100 000101 - XX



HSPL 120

30120 000101 - XX

HSCL - Classic

HIDDEN HANDLE



HSCL 100

article no. 30100 000102 - XX



HSCL 120

30120 000102 - XX

Colour Range Wall Cupboards

stainless steel



gloss powder coating

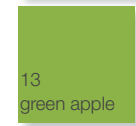
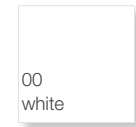

matt powder coating

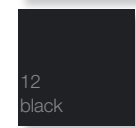

structure powder coating

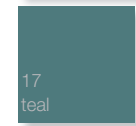

Cupboards

HSDH WALL CUPBOARD WITH EXTRACTOR HOOD

THE ADD-ON FOR EVEN MORE FUNCTION

Our 60 cm wide wall unit with integrated, pull-out extractor hood matches our wall units beautifully and complements your kitchen perfectly.

Design and function in perfect harmony, the wall unit offers both a built-in extractor and storage space behind the handleless door.



This wall cupboard is available in heights of 56 cm and 72 cm in all our kitchen colors. Depending on the version, the cupboard contains one or two shelves.

The extractor hood can be used in recirculation or exhaust air mode. The supplied grease filter can be easily cleaned in the dishwasher, and a charcoal filter for recirculating air is also included.

HSDH 60 - H560 Wall cupboard with extractor hood height 56cm

dimensions: W/D/H 60 x 36 x 56 cm
including extractor hood
one shelf

| article no. | colour | description |
|------------------|--------|---|
| 30060 051000 -XX | | wall cupboard - height 56 cm - door hinge right |
| 30060 052000 -XX | | wall cupboard - height 56 cm - door hinge left |

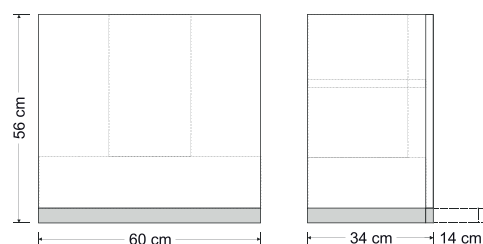

Colour Range HSDH 60

| | |
|----|-----------------|
| 00 | white |
| 01 | stainless steel |
| 03 | bordeaux |
| 11 | sand |
| 12 | black |
| 13 | green apple |
| 14 | mocha metallic |
| 15 | slate grey |
| 17 | teal |

HSDH 60 - H720 Wall cupboard with extractor hood height 72cm

dimensions: W/D/H 60 x 36 x 72 cm
including extractor hood
two shelves

| article no. | colour | description |
|------------------|--------|---|
| 30060 061000 -XX | | wall cupboard - height 72 cm - door hinge right |
| 30060 062000 -XX | | wall cupboard - height 72 cm - door hinge left |

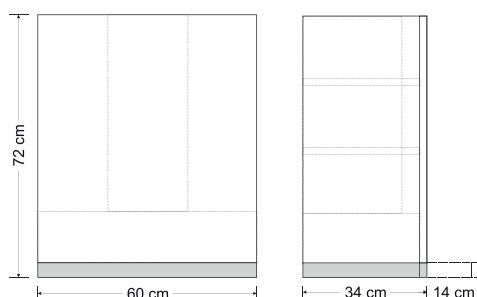



Cupboards

HSMW WALL CUPBOARD WITH MICROWAVE

GET EVEN MORE INTO THE SMALLEST SPACE

This cupboard with integrated microwave significantly improves the possibilities to complement your [Stengel mini kitchen](#). The shelf on top offers additional storage space.

The clever design ensures optimal ventilation for the 20l microwave oven combination, that's why the cupboard and microwave are always supplied as one unit.

The cupboard is finished either in white powder coated steel or in stainless steel, both these finishes match all ranges of [Stengel kitchens](#). Available in white and stainless steel, and of course also in heights of 560 and 720mm. The stainless steel 20 litre microwave with baking function is used in all versions

HSMW 60 - H560

Wall cupboard with microwave hight 56cm

dimensions: W/D/H 60 x 36 x 56 cm
including microwave

| article no. | - colour | description |
|-----------------|----------|---|
| 30060 030000 00 | | wall cupboard - hight 56 cm - white |
| 30060 030000 01 | | wall cupboard - hight 56 cm - stainless steel |

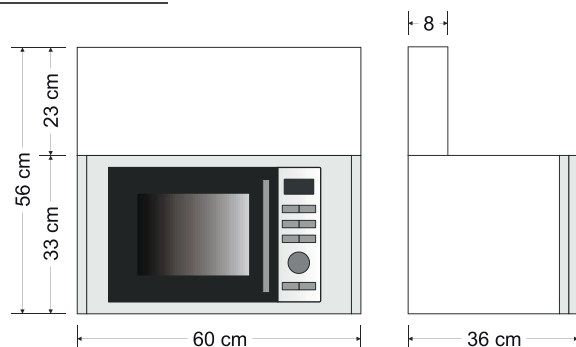

HSMW 60 - H720

Wall cupboard with microwave hight 72cm

dimensions: W/D/H 60 x 36 x 72 cm
including microwave

| article no. | - colour | description |
|-----------------|----------|---|
| 30060 040000 00 | | wall cupboard - hight 72 cm - white |
| 30060 040000 01 | | wall cupboard - hight 72 cm - stainless steel |

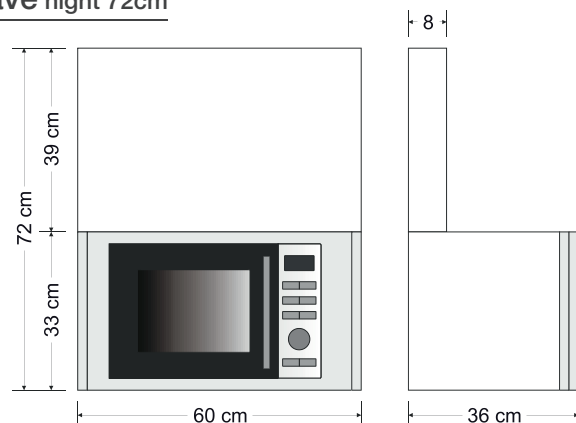



Cupboards

HO LARDER CUPBOARD

REALLY BIG STORAGE

Whether as addition to your kitchen or as addition to your apartment furniture - our tall cupboard offers not only offers enormous storage space, but also perfectly matches your minikitchen.

The doors and sides are double walled with insulation to give strengths and a solid feel and the carcass is made of powder coated metal. Every **HO - larder cupboard** is delivered with one fixed shelf and four adjustable shelves. The **HOB - larder cupboard** is equipped with an oven at a comfortable working height, there is a shelf behind each door. Our standard tall cupboards are available in white or a choice of our colourrange.

All tall cupboards are delivered assembled.

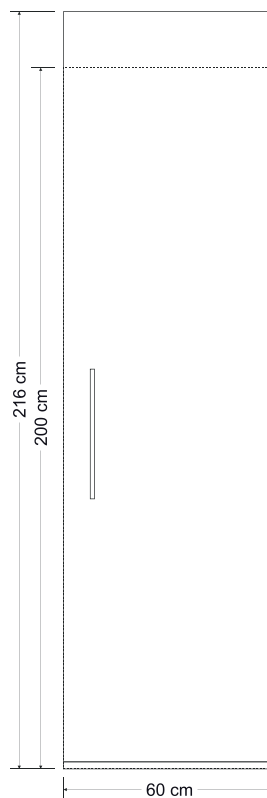

drawing: HO - H2000/H2160

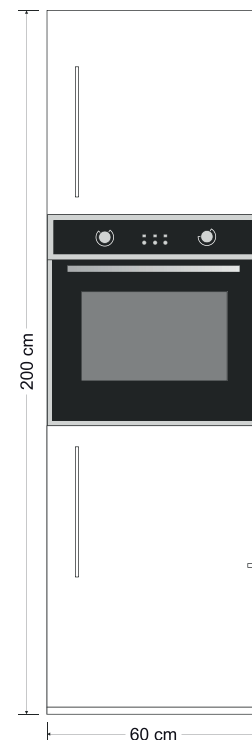

HOB - H2000

HO - H2000

Larder cupboard - 200cm

dimensions: W/D/H 60 x 60 x 200 cm

article no. - colour

34060 100001 - XX

34060 200001 - XX

description

larder cupboard 60 wide - door hinge right

larder cupboard 60 wide - door hinge left

HO - H2160

Larder cupboard - 216cm

dimensions: W/D/H 60 x 60 x 216 cm

article no. - colour

34060 100101 - XX

34060 200101 - XX

description

larder cupboard 60 wide - door hinge right

larder cupboard 60 wide - door hinge left

HOB - H2000

Larder cupboard with oven

dimensions: W/D/H 60 x 60 x 200 cm

inklusive Backofen

article no. - colour

34060 106005 - XX

34060 206005 - XX

description

larder cupboard 60 wide - door hinge right

larder cupboard 60 wide - door hinge left



Cupboards

Colour Range Larder Cupboard

gloss powder coating



matt powder coating

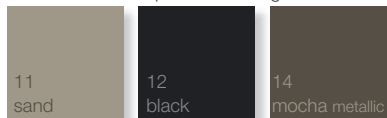

structure powder coating

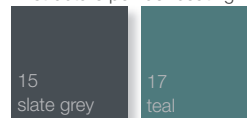

WR WALL RACK

LIGHT UND FILIGREE...

...these shelves complement your mini kitchen.

Stylish space for this and that - our new shelves combine useful and practical.



R-Slim



E-Slim

Colour Range Wall Rack

| | |
|----|----------------|
| 00 | white |
| 03 | bordeaux |
| 11 | sand |
| 12 | black |
| 13 | green apple |
| 14 | mocha metallic |
| 15 | slate grey |
| 17 | teal |

Wall rack - E-Slim and R-Slim

dimensions: W/D/H 50 x 15 x 15 cm
powder coated metal

| article no. | colour | description |
|-------------------|--------|-------------------------------------|
| 69050 100000 - XX | | wall rack E-Slim 50cm - edge shape |
| 69050 200000 - XX | | wall rack E-Slim 50cm - round shape |

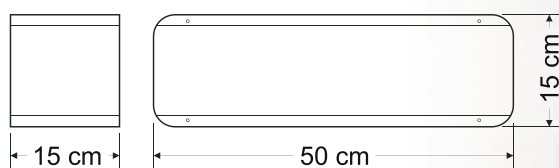
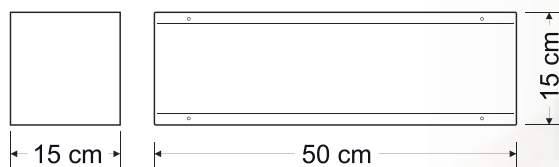



picture: wall rack with MPMOS160
in colour mocha metallic

WALL TRIMS FOR PREMIUM KITCHEN

Wall trims allow you to create an extra 30mm space for installation behind the kitchen. They are made of 0.7mm 1.4301 stainless steel to perfectly match the stainless steel covers of our Premiumline kitchens. Wall trims are available in different widths 100 - 110 - 120 - 150 - 160 - 170 - 180 cm.



Wall trims stainless steel

| article no. | dimensions: W/D/H 100-180 x 7 x 3 cm |
|-----------------|--------------------------------------|
| 63100 100000 01 | 100 cm wide |
| 63110 100000 01 | 110 cm wide |
| 63120 100000 01 | 120 cm wide |
| 63150 100000 01 | 150 cm wide |
| 63160 100000 01 | 160 cm wide |
| 63170 100000 01 | 170 cm wide |
| 63180 100000 01 | 180 cm wide |



SPLASH BACKS & SIDE CHEEKS

STAINLESS STEEL

Our **stainless steel splash backs** and side cheeks are the perfect link between the kitchen base units and metal wall cupboards. They are made from quality 1,0 mm brushed stainless steel. **Splash backs** are available in different widths 90 - 100 - 110 - 120 - 150 - 160 - 170 - 180 cm.



Splash backs stainless steel

| article no. | dimensions: W/D/H 90-180 x 55 x 1 cm |
|-----------------|--------------------------------------|
| 64090 000000 01 | 90 cm wide |
| 64100 000000 01 | 100 cm wide |
| 64110 000000 01 | 110 cm wide |
| 64120 000000 01 | 120 cm wide |
| 64150 000000 01 | 150 cm wide |
| 64160 000000 01 | 160 cm wide |
| 64170 000000 01 | 170 cm wide |
| 64180 000000 01 | 180 cm wide |

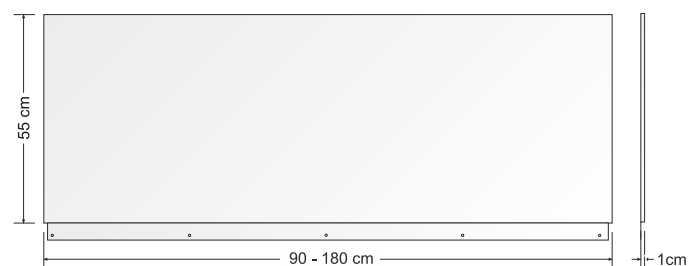

Side cheeks stainless steel

| article no. | dimensions: W/D/H 59 x 55 x 1 cm |
|-----------------|--|
| 65059 000000 01 | 59 cm wide - universal - can be used on both sides |

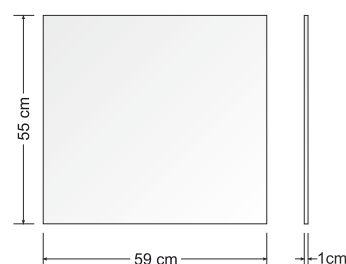

ACCESSORIES

FOR OUR MINI KITCHEN

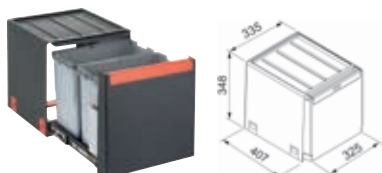

article no. 69001 000000 02

Waste bin - CUBE 40

suitable to 40 cm cupboard manual rails grey / black
assembly system two bins 14 litres
two point waste separation dimensions: 335 x 348 x 407 mm (WxHxD)



article no. 69001 000000 07

Waste bin - CUBE 50

article no. 69001 000000 05

suitable to 50 cm cupboard manual rails grey / black
assembly system dimensions: 438 x 345 x 330 mm (WxHxD)
two point waste separation - bins 18 litre + 14 litres
three point waste separation - bins 2x8 litre + 14 litres



article no. 69005 000000 04

Drawer organiser - Excellent II

article no. 69005 000000 00

article no. 69005 000000 01

article no. 69005 000000 03

colour grey plastic material 2,5 mm
drawer organiser 40 dimensions: 330 x 50 x 440 mm (WxHxD)
drawer organiser 50 dimensions: 430 x 50 x 440 mm (WxHxD)
drawer organiser 60 dimensions: 530 x 50 x 440 mm (WxHxD)
drawer organiser 70 dimensions: 630 x 50 x 440 mm (WxHxD)



article no. 62040 000000 00

article no. 62050 000000 00

article no. 62060 000000 00

article no. 62070 000000 00

Shelf - metal for stengel minikitchen

shelf for base units including fixings
metal powder coated white pre-cut holes for one shelf per cupboard unit!
model 40 cm white metal finish
model 50 cm white metal finish
model 60 cm white metal finish
model 70 cm white metal finish



article no. 69007 000000 02

Tray - for pull-out-unit 20cm

suitable for the pull-out-unit 20cm (from 2022) width 20cm
colour grey / powder coated dimensions: 100 x 400 x 450mm (WxHxD)

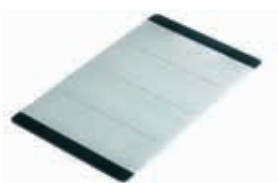

article no. 69009 000000 00

Cutting board glas

suitable to sink Line 60 (installed in all MP Premiumline kitchens)
weight 650 g
safety glas dimensions: 355 x 215 x 12 mm (WxDxH)



article no. 69010 000000 00

Cutting board wood

suitable to sink Line 60 (installed in all MP Premiumline kitchens)

beech wood

weight 1270 g

dimensions: 360 x 220 x 25 mm (WxDxH)



article no. 69011 000000 00

Draining basin RSF - stainless steel

suitable to sink Line 60 (installed in all MP Premiumline kitchens)

weight 545 g

stainless steel

dimensions: 171 x 360 x 75 mm (WxDxH)

TAPS



All **KLUDI** taps offer the following added values:

Flow class A - noise group I - rapid installation set - flexible connecting hose G 3/8 - ceramic cartridge with hot water safety device - 5 years guarantee - after sales service



One-handle mixer - Kludi Scope

DN 10, chrome, for 35 mm tap hole, rotatable 360°

article no. 60013 000000 00

low pressure

article no. 60014 000000 00

high pressure



One-handle mixer - Kludi Zenta

DN 10, chrome, for 35 mm tap hole, rotatable 360°

article no. 60016 000000 00

high pressure



One-handle mixer - Bingo Star

DN 10, chrome, for 35 mm tap hole, rotatable 360°

article no. 60017 000000 00

high pressure



One-handle mixer - Kludi L-line S

DN 10, chrome, for 35 mm tap hole, rotatable 360°

article no. 60018 000000 00

high pressure



One-handle mixer - Kludi Steel - stainless steel

DN 10, brushed stainless steel, for 35 mm tap hole, rotatable 360°

article no. 60022 000000 00

high pressure

ELECTRICAL EQUIPMENT

FOR OUR MINI KITCHEN



article no. 46005 000000 00

Fridge - Stengel KS 5002 EU

| | |
|-------------------------------|--|
| capacity gross 114 litres | 4* freezer / EEF- Class E |
| capacity net 100 litres | automatic defrosting system |
| freezer compartment 14 litres | connection 220 - 240 V / 50 Hz |
| sound level 41dB (A) - C | climate class ST/N (10°-38°C) |
| weight 27,5 kg | cooling agent R 600 A / FCKW-free |
| LED - Interior lighting | dimensions: 820 x 497 x 579 mm (HxWxD) |



article no. 46004 000000 00

Fridge - Stengel KU 1102 EU

| | |
|------------------------------|--|
| capacity gross 82 litres | 2* freezer / EEF- Class E |
| capacity net 74 litres | energy consumption 106,0 kWh / Jahr |
| freezer compartment 8 litres | connection 220 - 240 V / 50 Hz |
| sound level 41dB (A) - C | climate class T/N (16°-43°C) |
| weight 22,5 kg | cooling agent R 600 A / FCKW-free |
| LED - Interior lighting | dimensions: 820 x 480 x 560 mm (HxWxD) |



article no. 42004 000000 00

Microwave - Amica MW 13150 W

| | |
|------------------------|--|
| 30 minute timer manual | volume 17 Liter |
| defrosting program | microwave 700 W / 6 levels |
| glass plate Ø245mm | connection 220-240 V / 50 Hz - 1200 W |
| weight 10,5 kg | dimensions: 262 x 452 x 335 mm (HxWxD) |



article no. 42012 000000 00

Microwave - Stengel STCOMBI 102 - 20I

| | |
|-----------------------|--|
| stainless steel front | volume 20 litres |
| turntable system | microwave 800 Watt |
| automatic programs | grill 1200 Watt |
| child-safety lock | heating air / oven 2200W |
| glass plate | connection: 230 - 240 V / 50 Hz |
| weight 13,7 kg | dimensions: 262 x 452 x 360 mm (HxWxD) |



article no. 42011 000000 00

Microwave combination -Russell Hobbs RHM3003-30I

| | |
|------------------------------|--|
| combination oven / microwave | volume 30 litres |
| glass plate | microwave 1450 W |
| automatic programs | grill 1100 W |
| child-safety lock | heating air / oven 2500 Watt |
| | connection: 230 - 240 V / 50 Hz |
| weight 19,9 kg | dimensions: 335 x 520 x 510 mm (HxWxD) |

You can find data sheets for our electrical appliances here:
www.minikuechen.de/download



article no. 69001 000000 01

Timer - for mini kitchen Kitchenline / Easyline

fits in all MK Kitchenline and Easyline models
(not compatible with Premiumline & cupboard kitchen)
2-pole switch up to 30 minutes
16 A / till 250 V



article no. 44003 000000 00

Oven - Stengel EBO9.3H

| | |
|------------------|--|
| 9 programs | power 3000 W |
| energy label A | energy use index 93,3 |
| volume 68 litres | connection 220-240V/50 Hz - 3000 W |
| weight 30,0 kg | dimensions: 595 x 595 x 550 mm (WxHxD) |



article no. 41012 000000 00

Dishwasher - Stengel GS6-6FI2

| | |
|------------------------------|--|
| dishwasher 6 place settings | drying performance index 1.07 |
| water consumption 6,5 litres | energy efficiency class F |
| 6 washing programmes | energy consumption Eco 0,61 kW/h |
| temperatures 40 - 60°C | accustic level 49 dB |
| | connection 230V / 50 Hz - 1170-1380 W |
| weight 20,0 kg | dimensions: 438 x 550 x 500 mm (HxWxD) |



article no. 41016 000000 00

Dishwasher - Stengel WGSP15-8FI

| | |
|---------------------------------|--|
| dishwasher 15 place settings | water consumption 9,8 litres |
| temperatures 45 - 65°C | energy efficiency class C |
| intensive washing zone | annual energy consumption 76 kW/h |
| indicator light, cutlery drawer | accustic level 38 dB |
| auto door opening | connection 230V / 50 Hz - 2100 W |
| weight 43,0 kg | dimensions: 815 x 598 x 550 mm (HxWxD) |

ELECTRICAL EQUIPMENT

FOR OUR MINI KITCHEN



article no. 43008 000000 00

Double ceramic hob - Stengel EB-GK2

| | |
|-----------------------------|--|
| touch control | high-speed plate Ø145 mm / 1200 W |
| 9 heating levels each plate | high-speed plate Ø180 mm / 1800 W |
| timer | 250 cm cable with angle plug |
| residual heat indicator | connection: 220 - 240 V / 50 Hz - 3000 W |
| weight 4,5 kg | dimensions: 288 x 53 x 520 mm (WxHxD) |



article no. 43012 000000 00

Double induction hob - Stengel - IF2BG

| | |
|-----------------------------|---|
| double induction hob | child-safety lock / overheat protection |
| touch control - timer | power level 3600 W (1500 / 2200 W) |
| Booster function | 250 cm cable with angle plug |
| 9 heating levels each plate | connection 220-240 V / 50 Hz |
| weight 4,2 kg | dimensions: 290 x 62 x 520 mm (WxHxD) |



article no. 4017 000000 00

Extractor hood - Wiggo WE-E513G

| | |
|---------------------------|--|
| width 50 cm - black glass | touch control |
| connection tube 125 mm | recirculation / exhaust air mode |
| lightning 2x 1W LED | acoustic level 63 dBA |
| 3 power levels | exhaust air max. 300 m³ / h |
| EEF-class D | connection 230 V / 50 Hz - 100 W |
| weight 6,4 / 6,7 kg | dimensions: 495x373x772-877 mm (WxDxH) |



article no. 45007 000000 00

Extractor hood - Amica UH17052-3-E -50cm

| | |
|-----------------------------|--|
| connection tube 125 mm | 3 power levels 105-173 m³ / h |
| lightning LED 4W | acoustic level 52 - 63 dBA |
| weight 3,9 kg / cabel 140cm | connection 230 V / 50 Hz - 90 W |
| EEF-class C | dimensions: 500 x 505 x 130 mm (WxDxH) |



article no. 45013 000000 00

Extractor hood - Amica UH17010-4-E -60cm

| | |
|------------------------------|--|
| connection tube 125 mm | 3 power levels 110-178 m³ / h |
| lightning LED 4W | acoustic level 53 - 63 dBA |
| Gewicht 3,9 kg / cabel 140cm | connection 230 V / 50 Hz - 90 W |
| EEF-class C | dimensions: 600 x 505 x 130 mm (WxDxH) |

You can find data sheets for our electrical appliances here:
www.minikuechen.de/download

article no. 45002 000000 00

Extractor hood - PKM UBH6002-2H- 60cm



| | |
|----------------------------------|--|
| recirculation / exhaust air mode | acoustic level 58 - max. 63 dBA |
| lightning LED 2,5W | annual energy consumption 35,4 kWh/year |
| power levels 220 - 301 m³ / h | energy efficiency class E / Fat separation effc. E |
| connection tube 125 mm | connection 220 - 240 V / 50 Hz - 67,5 W |
| weight 6,0 kg | dimensions: 600 x 280-430 x 176 mm (WxDxH) |

article no. 47003 000000 00

Water heater - Dimplex ACK 5 U



| | |
|--------------------------------|--|
| 5 Liter Volumen, depressurised | class A |
| wall mounting | |
| water temperature 35 - 85°C | connection: 230 V / 50 Hz - 2000W |
| degree of protection IP24 | protection class I splash-proof |
| weight 3,5 kg | dimensions: 256 x 213 x 390 mm (WxDxH) |

article no. 47007 000000 00

Light strip - alu / stainless steel with 2 sockets



| | |
|-------------------------------|--------------------------------------|
| LED - light strip with switch | housing in aluminum/stainless steel |
| 2 sockets | connection: 230 V / 50 Hz |
| light colour 4000 K white | 644 lumen - 6,5 W |
| | dimensions: 560 x 71 x 71 mm (WxDxH) |

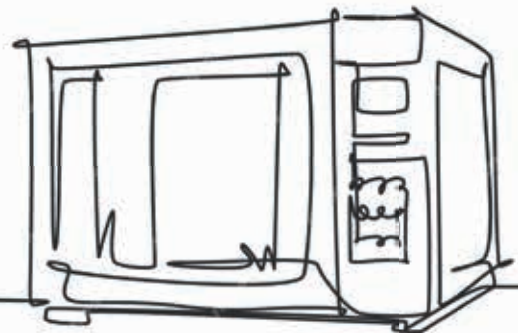

PROJECTS

Welcome to the world of kitchen projects!

Discover a diverse selection of inspiring kitchen design solutions for your property in our catalogue.

Stengel metal kitchens impress with their durability, high-quality materials, easy installation, high fire protection compliance, low follow-up costs and modern design.

We offer a wide range of options to realise your individual ideas.

Whether for student or retirement homes, holiday homes, office or apartment complexes - we have the ideal solution for you.

Our strengths for your project:

We support you personally and professionally from the initial idea to completion. Whether you are an architect, planning office or construction company, we are at your side in all matters. Thanks to many years of experience in project planning and our in-house design department, our team can respond specifically to your individual requirements and also realise custom-made products promptly and professionally.

Our extensive list of references at home and abroad is proof of our strong performance in the project sector.

For a detailed overview, please visit our website.

We look forward to working with you to plan and realise your kitchen project.





PROJECTS

...in Germany and all over Europe





COMPANY

Stengel Steel Concept GmbH...

...stands for clear forms, clever realisation, simplicity, high-quality materials, full functionality in the smallest of spaces and technical equipment at the highest level.

As a sales branch of Stengel GmbH based in Ellwangen/Baden Württemberg, we have all the techniques and possibilities of metal processing at our disposal. Here we benefit from our own design and production.



Stengel GmbH

Production with maximum flexibility and productivity

Thanks to state-of-the-art forming and manufacturing processes, there are almost no limits to the designs and constructions possible in sheet metal production today.

Stengel GmbH is a medium sized family owned company with more than 40 years of experience in sheet metal production. With more than 1000 employees, approximately 135.000 m² of production and storage area, our own powder coating facility and state of the art machinery, **Stengel GmbH** is able to meet the demands of today's market. As well as a large range of mini kitchens Stengel GmbH manufactures more than 50.000 products, including wet room units for cruise liners and building construction, server cabinets, office furniture, shop displays and many more products for well-known companies throughout Europe.



DELIVERY FOR OUR MINI KITCHENS

We guarantee fast and reliable delivery together with our partner companies.



PACKAGING

All **kitchen** models are specially packed to reduce damage and delivered on pallets for easy handling on site.

Electric appliances that are not integrated in the kitchens such as ovens, microwaves or dishwashers, are delivered with the kitchen and securely fastened.

OUR LOGISTIC- AND SERVICE PARTNER

The logo for Stengel, featuring the word "stengel" in a stylized, italicized orange font with a white outline.The logo for Dachser, consisting of the word "DACHSER" in blue capital letters above the tagline "Intelligent Logistics" in black, all contained within a yellow rectangular background.The logo for Spedition Pfeleiderer, featuring a blue stylized 'F' icon to the left of the text "SPEDITION PFLEIDERER" in red, with the tagline "MÖBELLOGISTIK IN PERFEKTION" in black below.

CONNECTION-SCHEME

CUPBOARD KITCHEN SKM

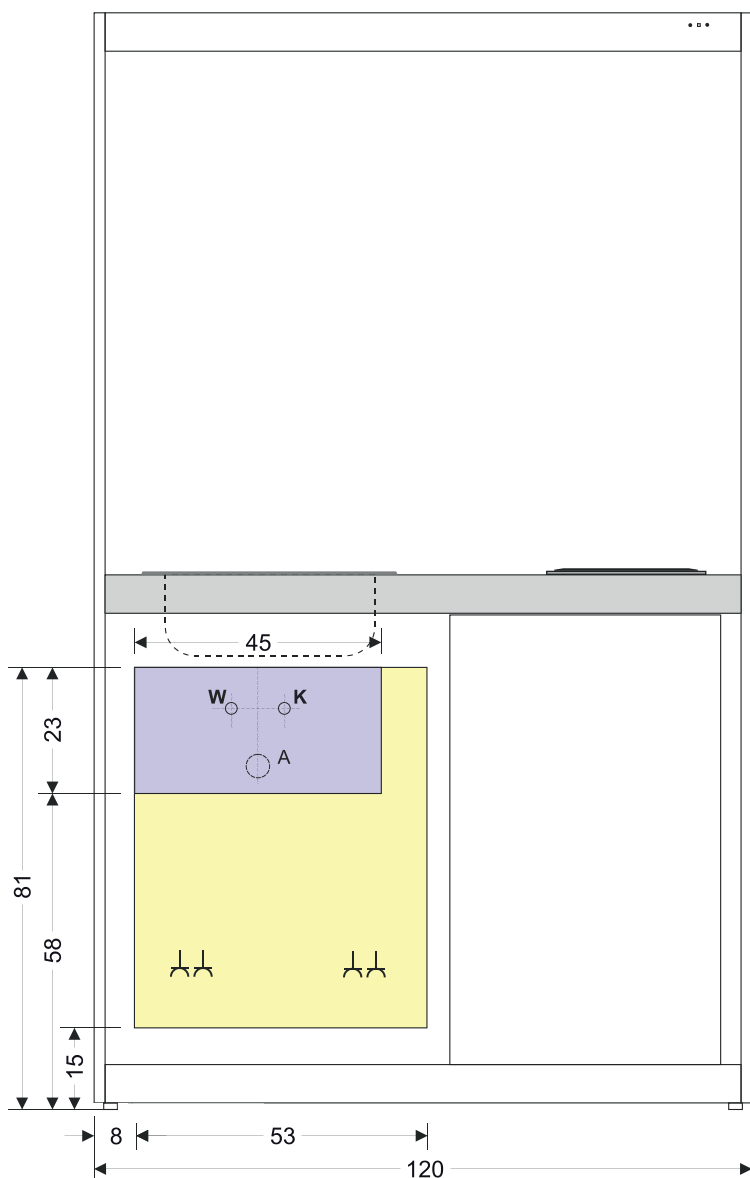

Information:



= Recommended area for water connections

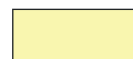

= Recommended area for electrical connections

= Outlets 230V upon quantity of el. circuits within the bounds of the installation area

H = Hot water connection

C = Cold water connection

A = Waste water connection

Scheme is connection advice. Modifications according upon structural conditions are possible.

Integrated safety switch (door switch-off):
1x 16 A for hob upon 3500W
1x 16 A for microwave/ light
(1 socket per circuit)

Direct circuit (without door switch):
1x 16 A for fridge/ dishwasher
(1 socket per appliances)



Important notice!!!

Figure with hotplates right bowl left. Please check before installation, which side of hotplates or bowl you have and install plugs reverse left to right accordingly.

Subsequent complaints are not accepted!

We recommend the installation of your kitchen by a plumbing or electrical specialist

CONNECTION-SCHEME

MINI KITCHEN MP - MK - ME

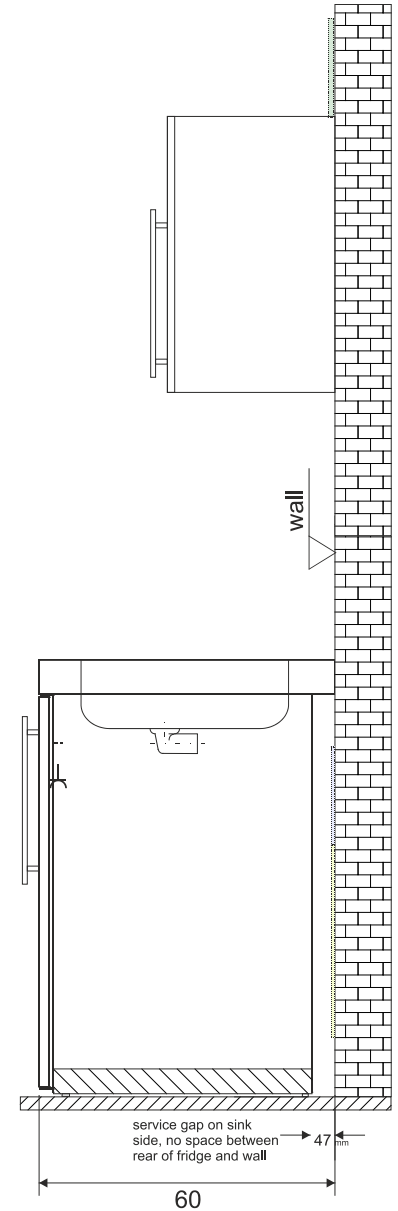
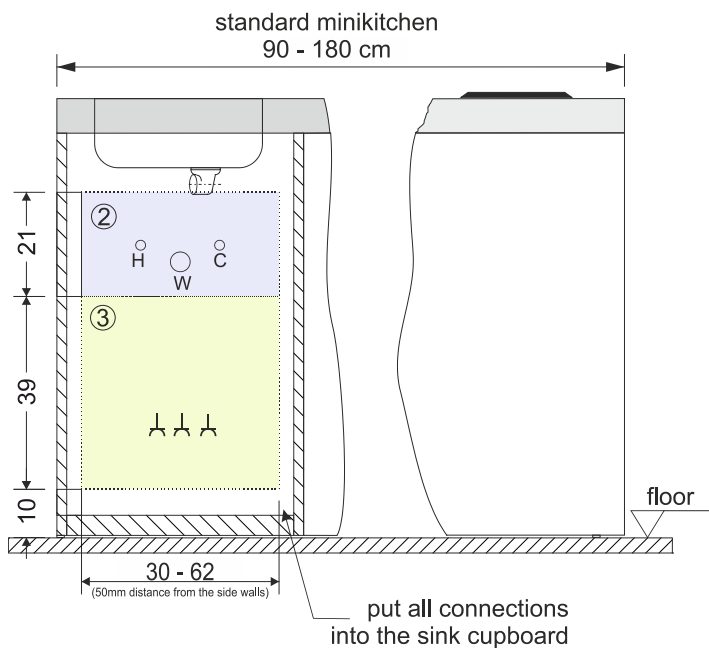
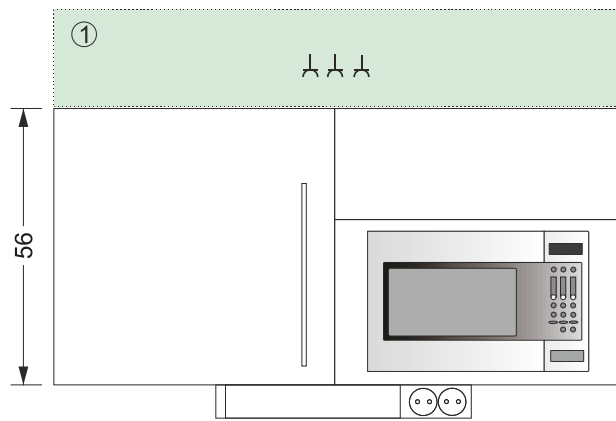

- ① Recommended area for electrical connections of wall cupboards (e.g. microwave, light strip, extractor hood etc.)
- ② Recommended area for water connections
- ③ Recommended area for electrical connections for mini kitchen (e.g. fridge, microwave, dishwasher, oven etc.)

Distances in the installation area:

| | | |
|---|---|------------|
| - wall - drawer | = | 130 mm |
| - wall - dishwasher | = | 65 mm |
| - wall - 4* fridge Stengel (MK / MP / MO) | = | 15-18 mm |
| - wall - 2* fridge Stengel (ME) | = | 50 mm |
| - wall - microwave 20l | = | 240-280 mm |
| - wall - micro-oven 30l | = | 100 mm |
| - wall - oven | = | 25 mm |
| - wall - shelf | = | 50 mm |

- Bases of the mini kitchens are delivered without rear panel
- Quantity of outlets according to quantity of electrical appliances
- All electrical appliances are 230V operated-
- Performance data of electrical appliances, see data sheets or current catalogue



Stengel Steel Concept GmbH

Wilhelm-Maybach-Str. 1-3

73479 Ellwangen

Germany

phone: +49 7961 9121 - 400

email: office@stengel-steelconcept.com

www.stengel-steelconcept.com

